



U.S.-Pakistan

Centers for Advanced Studies in Water



# Simulation Modeling and Analysis of Household Water Consumption in Pakistan using Hybrid Approach

## Final Report 2019

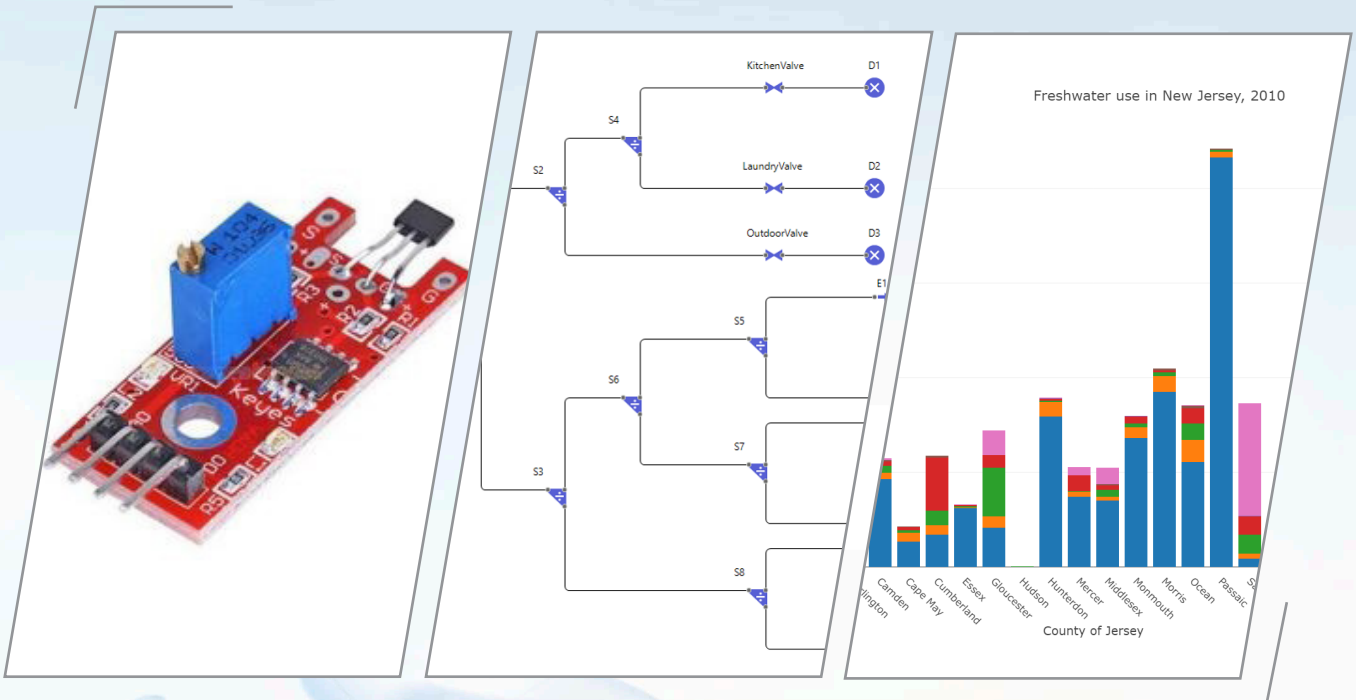

### Principal Investigator:

**Dr. Imran Mahmood, Department of Computing  
Center for Research in Modeling & Simulation (CRIMSON)  
National University of Sciences & Technology, Islamabad, Pakistan**

### Co-Principal Investigator:

**Dr. Naveed Arshad, National Center in Big Data and Cloud Computing (NCBC)  
Lahore University of Management Sciences, Lahore, Pakistan**



**MEHRAN UNIVERSITY**  
of Engineering & Technology  
Jamshoro, Sindh, Pakistan



**Citation**

Mahmood, I., and Arshad, N. (2019). Simulation modeling and analysis of household water consumption in Pakistan using hybrid approach. U.S.-Pakistan Center for Advanced Studies in Water (USPCAS-W), MUET, Jamshoro, Pakistan

© All rights reserved by USPCAS-W. The authors encourage fair use of this material for non-commercial purposes with proper citation.

**Authors**

1. Dr. Imran Mahmood, Department of Computing, Center for Research in Modeling & Simulation (CRIMSON), National University of Sciences & Technology, Islamabad, Pakistan
2. Dr. Naveed Arshad, National Center in Big Data and Cloud Computing (NCBC), at Lahore University of Management Sciences, Lahore, Pakistan

**ISBN**

978-969-7970-07-0

---

**Acknowledgment**

This work was made possible by the support of the United States Government and the American people through the United States Agency for International Development (USAID).

**Disclaimer**

The contents of the report are the sole responsibility of the authors and do not necessarily reflect the views of the funding agency and the institutions they work for.



U.S.-Pakistan

Centers for Advanced Studies in Water



# Simulation Modeling and Analysis of Household Water Consumption in Pakistan using Hybrid Approach

## Final Report 2019

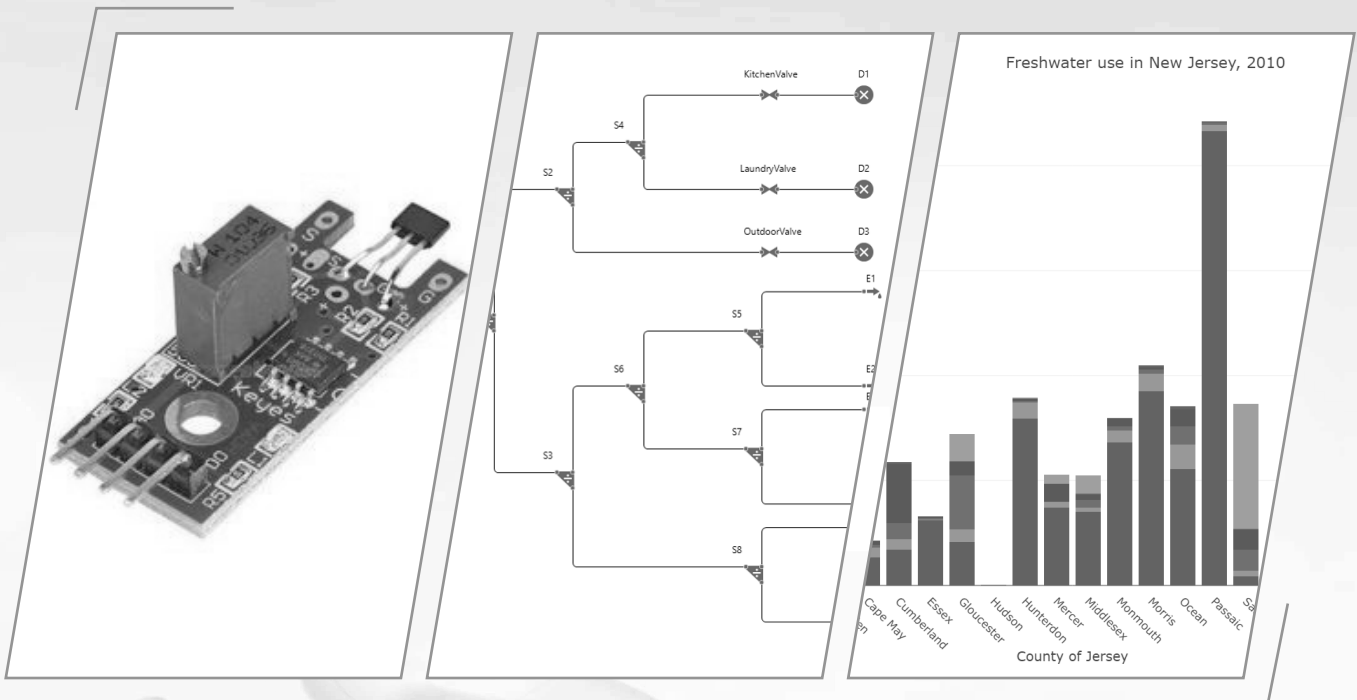

### Principal Investigator:

**Dr. Imran Mahmood, Department of Computing  
Center for Research in Modeling & Simulation (CRIMSON)  
National University of Sciences & Technology, Islamabad, Pakistan**

### Co-Principal Investigator:

**Dr. Naveed Arshad, National Center in Big Data and Cloud Computing (NCBC)  
Lahore University of Management Sciences, Lahore, Pakistan**



**MEHRAN UNIVERSITY**  
of Engineering & Technology  
Jamshoro, Sindh, Pakistan



## **Project Team**

### **Principal Investigator**

Dr. Imran Mahmood

Department of Computing

Center for Research in Modeling & Simulation (CRIMSON)

National University of Sciences & Technology, Islamabad, Pakistan

### **Co-Principal Investigator**

Dr. Naveed Arshad

National Center in Big Data and Cloud Computing (NCBC)

Lahore University of Management Sciences, Lahore, Pakistan

### **Research Team**

- Ms. Romana Ali (Research Associate)  
Department of Computing  
Center for Research in Modeling & Simulation (CRIMSON)  
National University of Sciences & Technology, Islamabad, Pakistan
- Mr. Ali Shafique Malik (Research Associate)  
Department of Electrical Engineering  
Center for Research in Modeling & Simulation (CRIMSON)  
National University of Sciences & Technology, Islamabad, Pakistan
- Ms. Momna Saeed (Research Associate)  
Department of Computing  
Center for Research in Modeling & Simulation (CRIMSON)  
National University of Sciences & Technology, Islamabad, Pakistan

# TABLE OF CONTENTS

LIST OF TABLES .....	IV
LIST OF FIGURES .....	V
LIST OF ABBREVIATIONS .....	VII
1. INTRODUCTION .....	1
1.1 Background and Rationale .....	1
1.2 Objectives .....	2
2. MATERIALS AND METHODS .....	3
2.1 Survey and Data Collection .....	3
2.1.1 Water utilities .....	3
2.1.2 Publicly available datasets .....	4
2.2 Conceptual Modeling and Design .....	6
2.2.1 Person .....	7
2.2.2 House .....	8
2.2.3 Input data .....	9
2.3 Model Implementation .....	9
2.3.1 Person .....	10
2.3.1.1 Input parameters .....	10
2.3.1.2 State chart .....	10
2.3.1.3 Washroom .....	11
2.3.1.4 Fluid flow .....	11
2.3.2 House .....	11
2.3.2.1 Input parameters .....	12
2.3.2.2 State chart .....	12
2.3.2.3 Fluid flow .....	13
2.3.3 Apartment .....	13
2.3.3.1 Input parameters .....	14
2.3.3.2 State Chart .....	14
2.3.3.3 Fluid flow .....	15
2.3.4 Block .....	15
2.3.4.1 Input parameters .....	16

2.3.4.2	Fluid flow . . . . .	16
2.3.5	Neighbourhood . . . . .	17
2.3.5.1	Input parameters . . . . .	17
2.3.6	Database . . . . .	18
2.3.7	Case Study . . . . .	19
2.3.8	Simulation . . . . .	19
2.3.8.1	House . . . . .	21
2.3.8.2	Block . . . . .	22
2.4	IoT Kit Development . . . . .	26
2.4.1	Consumption monitoring module . . . . .	26
2.4.1.1	Water flow sensor . . . . .	27
2.4.1.2	NodeMCU . . . . .	28
2.4.1.3	Consumption monitoring module calibration . . . . .	28
2.4.1.4	Tape calibration measurement module . . . . .	28
2.4.2	Tap monitoring module (A) . . . . .	29
2.4.2.1	Piezoelectric vibration sensor . . . . .	30
2.4.2.2	NodeMCU: . . . . .	30
2.4.3	Tap monitoring module (B) . . . . .	31
2.4.3.1	Magnets . . . . .	31
2.4.3.2	Linear magnetic Hall sensor . . . . .	31
2.4.3.3	Arduino . . . . .	32
2.4.4	Consumption display module . . . . .	32
2.4.4.1	NodeMCU . . . . .	33
2.4.4.2	Liquid crystal display . . . . .	33
2.4.4.3	LCM1602 IIC (I2C) . . . . .	34
2.4.5	Server-side module . . . . .	34
2.4.6	IoT Kit data collection . . . . .	34
2.5	Dashboard and Visualization of Simulation Model . . . . .	37
3.	RESULTS AND DISCUSSION . . . . .	38
3.1	Neighborhood Level . . . . .	38
3.1.1	Daily water consumption of neighbourhood for a month . . . . .	38

3.1.2	Daily water consumption of neighbourhood for a year . . . . .	39
3.2	House Level . . . . .	40
3.3	Validation and Discussion . . . . .	40
3.4	Research Output . . . . .	41
3.4.1	Conference proceedings . . . . .	41
3.4.2	Research papers . . . . .	41
3.4.3	M.Sc. thesis . . . . .	42
3.4.4	Project results dissemination open house/seminar . . . . .	42
3.4.5	Patents . . . . .	42
4.	CONCLUSION AND RECOMMENDATIONS . . . . .	43
4.1	Conclusion . . . . .	43
4.2	Recommendations . . . . .	43
	REFERENCES . . . . .	45

# LIST OF TABLES

Table 2.1:	Availability and water consumption behavior of different age groups .....	8
Table 2.2:	Model input .....	9
Table 2.3:	Data of the residential area of NUST .....	19
Table 2.4:	Consumption monitoring module table .....	36



# LIST OF FIGURES

Fig. 2.1:	Monthly residential water consumption, DHA Lahore.....	4
Fig. 2.2:	Monthly water consumption in DHA Islamabad.....	4
Fig. 2.3:	Monthly water consumption in Austin, USA, by different consumer classes.....	5
Fig. 2.4:	Daily water consumption by different consumer sectors in New Jersey, USA.....	5
Fig. 2.5:	Monthly residential water consumption in New Jersey (2010 to 2017).....	6
Fig. 2.6:	State chart showing water consumption behavior of a person.....	7
Fig. 2.7:	Water consumption behavior of a house.....	8
Fig. 2.8:	Water consumption behavior of a household showing stocks and waterflows.....	9
Fig. 2.9:	Behavior of a person in water consuming activities.....	11
Fig. 2.10:	Washroom fluid flow structure.....	12
Fig. 2.11:	Behavior of a house in water consuming activities.....	13
Fig. 2.12:	Fluid flow structure of a house.....	14
Fig. 2.13:	Behavior of an apartment in water consuming activities.....	15
Fig. 2.14:	Fluid flow structure of an apartment.....	16
Fig. 2.15:	Fluid flow structure of a block.....	17
Fig. 2.16:	Entity relationship diagram.....	18
Fig. 2.17:	The trend of water consumption activities inside NUST.....	20
Fig. 2.18:	The trend of person availability inside NUST.....	20
Fig. 2.19:	2D simulation dashboard of the NUST case study.....	20
Fig. 2.20:	NUST Villas & ISRA Apartments.....	21
Fig. 2.21:	Parameters, variables, functions and behaviour of the house agent.....	21
Fig. 2.22:	Parameters, variables, functions and behaviour of a person agent.....	22
Fig. 2.23:	House fluid flow structure with washroom fluid flow.....	23
Fig. 2.24:	Parameters, variables, functions and behaviour of an apartment agent.....	24
Fig. 2.25:	Parameters, variables, functions and behaviour of a person agent.....	24
Fig. 2.26:	Block fluid flow structure.....	25
Fig. 2.27:	Hardware architectural diagram of the IoT Kit.....	26
Fig. 2.28:	Circuit diagram of the consumption monitoring module.....	27
Fig. 2.29:	Water flow sensor.....	27
Fig. 2.30:	NodeMCU.....	28
Fig. 2.31:	Tap calibration measurement module.....	29
Fig. 2.32:	Circuit diagram of the tap monitoring module (A).....	30
Fig. 2.33:	Piezoelectric vibration sensor.....	30
Fig. 2.34:	Tap monitoring module (B).....	31

Fig. 2.35:	Magnet.....	31
Fig. 2.36:	Linear magnetic Hall sensor .....	32
Fig. 2.37:	Arduino UNO .....	32
Fig. 2.38:	Water consumption display module.....	33
Fig. 2.39:	Liquid crystal display (LCD).....	34
Fig. 2.40:	LCM 1602 IIC (I2C) .....	34
Fig. 2.41:	Database tables .....	35
Fig. 2.42:	Dashboard graph view .....	37
Fig. 3.1:	Water consumption at neighborhood level (200 houses) at NUST, Islamabad ...	38
Fig. 3.2:	Monthly aggregate of the water consumption in the neighbourhood at NUST, Islamabad.....	39
Fig. 3.3:	Monthly aggregate of the water consumption in the neighbourhood for a whole year at NUST, Islamabad .....	39
Fig. 3.4:	Water consumption of a house at NUST, Islamabad.....	40
Fig. 3.5:	Actual demand (red line) and simulated (blue line) monthly water consumption of NUST housing .....	41

# LIST OF ABBREVIATIONS

ABM	Agent-based Modeling
API	Application Programming Interface
CRIMSON	Center for Research in Modeling & Simulation
DHA	Defense Housing Authority
GIS	Geographic Information System
GND	Ground
GRID	Grid
GSA	Grid Station A type
GSB	Grid Station B type
ICT	Information and Communication Technology
IDE	Integrated Development Environment
IEEE	Institute of Electrical and Electronics Engineering
IoT	Internet of Things
IP	Intellectual Property
IQRA	Name of NUST Apartment
ISRA	Name of NUST Apartment
KPI	Key Performance Indicator
LCD	Liquid Crystal Display
LCM	LCM1602 IIC interface LCD
MCU	NodeMCU
NCBC	National Center in Big Data and Cloud Computing
NUST	National University of Sciences and Technology
PMO	Project Management Office
SDG	Sustainable Development Goals
SEECS	School of Electrical Engineering and Computer Science
TCP	Transmission Control Protocol
WEAP	Water Evaluation and Planning System
WSC	Winter Simulation Conference

# ACKNOWLEDGMENTS

We would like to express our deepest appreciation to all those who provided guidance and support to complete this project. We would also like to expand our deepest gratitude to all those who have guided us during this project. We thank NUST PMO office for providing us the data for the campus and the residential water supply and consumption. We also thank Defense Housing Authority, Lahore, for providing us validation data.

We appreciate and applaud the efforts of the Research Associates and the MS students, Romana Ali, Momna Saeed, and Ali Shafique Malik, who were all involved in the project activities viz. modeling, simulation, hardware development, data analyses and report writing. We also acknowledge the contributors Sulman Shaukat, Talha Nadeem, Arooj Nawaz, Muhammad Saad Alvi and Muhammad Salman Yaseen, who helped to coordinate project activities with suggestions and encouragement.

We also wish to extend sincere thanks to Dr. Kazi Suleman, Manager Research USPCAS-W, for providing assistance in editing of the report. We are also highly thankful to the United States Agency for International Development (USAID), Pakistan for funding this project through the U.S.- Pakistan Center for Advanced Studies in Water (USPCAS-W), Mehran University of Engineering & Technology (MUET), Jamshoro.

# EXECUTIVE SUMMARY

Water scarcity is affecting the availability of freshwater resources in many regions of the world. Driven by two converging phenomena, growing freshwater use and depletion of usable freshwater resources, the situation aggravates over time. Furthermore, it is expected that the urban population will exceed the rural population by 2050 due to rapid urbanization. Hence, water resource management in urban areas is also essential like other water-consuming sectors, i.e. agriculture and industrial. Water resource management can be done by both supply-side management and consumption side management. A lot of work has been done on supply-side management. Still, due to the lack of proper water metering systems at the household level in many countries like Pakistan, consumption side management is challenging. Pakistan is rapidly becoming a water-stressed country, thus affecting people's wellbeing. The situation demands drastic water conservation policies and practices to effectively manage available water resources and efficient water supply delivery coupled with responsible demand-side management.

This study attempted to develop a simulation modeling and analysis framework for household water consumption in an urban area of Pakistan using a hybrid. This framework allows the modeler to analyse and forecast household water demand. It involved (i) Agent-Based Modeling (ABM) paradigm that takes into account the behavior and characteristics of individuals and (ii) System Dynamics (SD) paradigm that accounts for water flow dynamics. The methodology provides dual resolution expressiveness suitable for replicating real-world urban infrastructure scenarios. The proposed framework uses a bottom-up agent-based modeling and fluid dynamics to simulate water consumption and the unmet demand of urban households. The water consumption of a house is simulated based on the inhabitant's behavior and interactions and simulates a water distribution system to see its effects on a neighbourhood's water consumption. Actors (houses, blocks, inhabitants, water storage tanks, tube wells) are modeled as agents, while the water distribution system is modeled using fluid dynamics. The global effect that emerges due to these agents' interaction helps water authorities devise new policies/strategies to fight against the problem of water scarcity.

The simulation framework will help develop strategies/policies for preventive demand-side management and will be used for better planning for supply and resource management. Our validated simulation framework is used for the behavioural analysis of water consumption in the domestic sector. It can be easily extended to industrial, commercial, and agricultural sectors using our component-based modeling approach. Eventually, it can be deployed as a decision support system. We further aim to extend the framework to support supply-side modeling at multiple levels of resolution and

incorporate water supply management processes under various scenarios of urban infrastructures.

The key objective of the research is to assist authorities in understanding and forecasting short-term and long-term water consumption by examining varying patterns of water consumption in different climates and thus improving demand-side water usage dynamically subject to water supply availability.

# 1. INTRODUCTION

## 1.1 Background and Rationale

United Nations Sustainable Development Goals (UN-SDGs) call for achieving the SDGs for the cities and communities (SDGs, 2018). Basic necessities such as water, energy, health care, sanitation, and education must be made available at doorsteps of the individuals to achieve this target (Guterres, 2017). Among these, domestic water consumption constitutes a major part of urban water demand (Linkola *et al.*, 2013). With the growth of population and the continuous rise in the inflow of urban population, the urban areas are facing a drastic decline in available water quantity and quality. Pakistan is at the 17<sup>th</sup> position in countries facing extreme water scarcity and health crisis due to unsafe drinking water (Altaf, 2017). It intensifies services like delivery of safe water, waste management, energy, health, school facilities and public safety to their critical limits; It impairs the availability of critical resources for a resilient and sustainable development urban infrastructure (Moon, 2016).

It is crucial, therefore, to adopt drastic measures in improving the performance of water services utilities, and better understand the demand side for effective water governance (Linkola *et al.*, 2013). A dynamic modeling and simulation framework can help improve water governance and develop strategies/policies for preventive demand-side management as well as better planning for supply and resource management. Household water simulation is the process of simulating the flow of water in different household water-consuming entities. It also helps in monitoring and effective distribution of water resources (Zaher and Badr, 2016).

Water supply and management has become a major issue due to climate change, depletion of natural resources, and rapid urbanization. The water regulatory authorities must forecast future demand and propose a resilient and sustainable infrastructure for effective water management (Butler *et al.*, 2016). There is no proper water metering in most parts of Pakistan's urban regions, and regulatory authorities have no data on water consumption and required water supply. Installing smart water meters requires significant funding and time commitment. It is, therefore, crucial to forecast the exact household water demand to best manage available water resources. This requires system analysis for combined demand and supply. Many existing approaches propose water resources planning and management analysis through modeling and simulation (Berglund, 2015).

Modeling and simulation enable us to replicate a real-world system for suitable risk-free dynamic experiments (Borshchev, 2013). Simulation models of water consumption

deal with modeling individual's water consumption behavior as agents, and modeling the external environment, supply process, and water flow as system dynamics. These external factors have significant importance in analyzing behavioral aspects (Galán *et al.*, 2009). Modeling and simulation of domestic water-consuming entities and water resources help in the analysis and management planning of water resources. It provides control over consumption by predicting the tasks which are necessary for satisfying the volumetric flow consumed. Modeling water consumption of different consumers, such as domestic, commercial, industrial and agricultural sectors helps forecast water demand by performing activity-based consumption and revealing insights into the demand dynamics (Linkola *et al.*, 2013).

This project proposed the development of a behavioral simulation model for household water consumption at a dual resolution (i.e., macro and micro level) using a hybrid approach. This approach combines (i) Agent-Based Modeling (ABM) to model individuals' water consumption behavior at a micro level, and (ii) System Dynamic (SD) approach to aggregate the modeled behavior of a population in an urban area, at a macro level to forecast short-term and long-term water demand. This research aims to develop a framework for the regulatory authorities, which can help monitor water resources, plan the adequate water supply at the household level, and forecast short-term and long-term water consumption demand. It further aids in gaining insights into the behavior patterns of water consumption in different areas and improving the performance of the water supply process through demand-side management.

## 1.2 Objectives

The research objective is to develop a framework for the authorities to forecast short-term and long-term water consumption demand, gain insights into the behavior patterns of water consumption in different areas, improve the performance of the water supply process through demand-side management, and plan effective water governance.

A simulation framework consisting of a dashboard will be provided to the regulatory authorities after completing the research. This dashboard will help the regulatory authorities properly plan and effectively manage water resources, overcome water scarcity, strengthen water governance, and improve water management. An IoT Kit will be developed for real-time monitoring and acquisition of household water consumption data. This low-cost kit will act as a smart water meter and can be easily deployed in different houses. It will directly be connected to a remote server for recording water consumption at sec/min/hourly resolution.



## 2. MATERIALS AND METHODS

This study attempted to develop a household water consumption simulator to model daily water consumption activities in a typical urban house, using a hybrid approach. Our hybrid approach combines (i) Agent-Based Modeling (ABM) to model individuals' water consumption behavior at a micro-level, and (ii) Fluid Dynamics to aggregate the modeled behavior of a population in an urban area, at a macro-level to forecast water demand. The methodology adopted for this study consisted of five steps, viz. survey and data collection, conceptual modelling and design, model implementation, IoT Kit development, and dashboard and visualization of a simulation model. Methodology details are given in the following sections.

### 2.1 Survey and Data Collection

Due to the lack of efficient metering systems, there is no data about people's water consumption behaviors in different activities. Therefore, a survey was conducted using a snowball sampling technique to get people's general behaviour in Punjab. The snowball sampling technique is also known as a chain referral technique in which the researcher nominates some samples and ask them to recommend other subjects; they know who fit the terms of needed samples. Thus, the sample group grows like a rolling snowball. This technique is used when people are less willing to give information, subjects are challenging to locate, the secrecy of the organisation's illegalities, or no obvious list of the population of interest. To model people's water consumption behaviour, we required to identify minor activities and their useful characteristics. These characteristics include activities penetration rate, consumption rate, actor (person who can perform the activity) frequency per day, activity type (how many times in a week or month), duration and diurnal activity occurrence probabilities. Also, the daily availability trend of different age groups is required to model water consumption. Therefore, we collected data through our survey from 250 houses (for collective activities of a house) and 460 individuals (for their activities and person availability trends).

Field survey and data collection activities were carried out through the following sources.

#### 2.1.1 Water utilities

We collected a dataset of water consumption of 1000 houses from DHA, Lahore. A representative plot of the average monthly water consumption of 2 kanal, 1 kanal, and 10 marla houses are shown in Fig. 2.1.

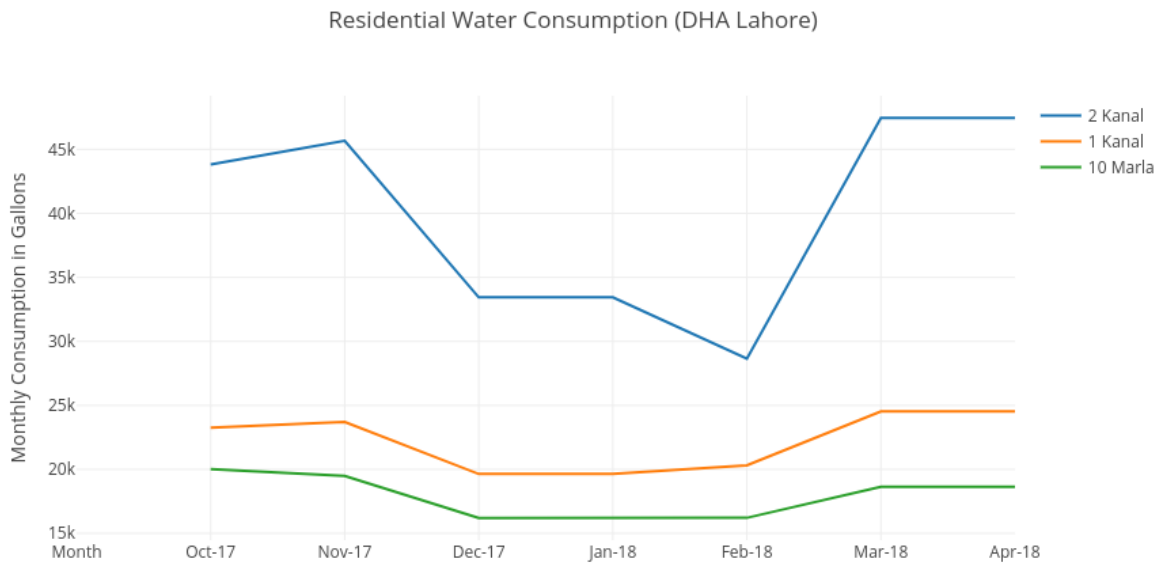

**Fig. 2.1: Monthly residential water consumption, DHA Lahore**

Similarly, we also gathered water consumption data of 5157 houses of DHA, Islamabad. A representative plot of the average monthly water consumption of 2 years is given in Fig. 2.2.

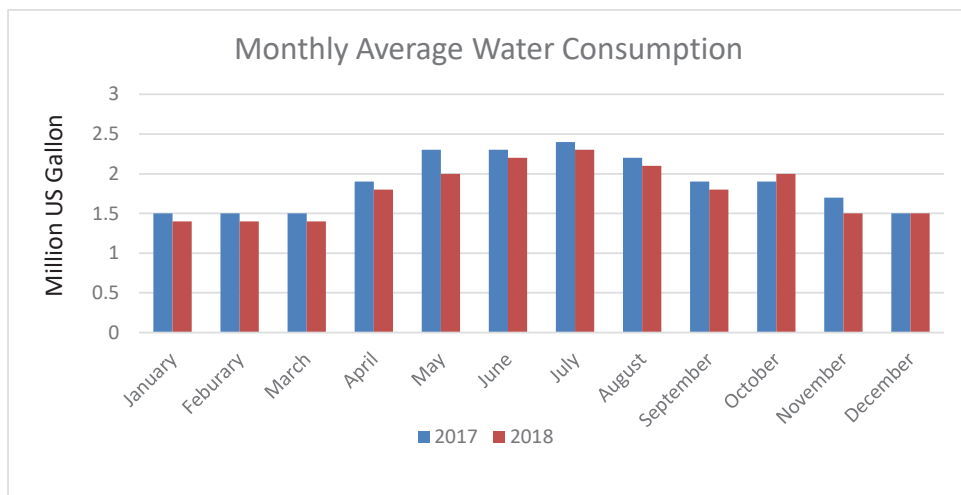

**Fig. 2.2: Monthly water consumption in DHA Islamabad**

### 2.1.2 Publicly available datasets

Monthly residential water consumption grouped by zip code and customer class of Austin is publicly available. Fig. 2.3 shows water consumed by different consumer classes, namely: Residential, Multi-Family, Irrigation – Residential, and Irrigation – Multi-Family.

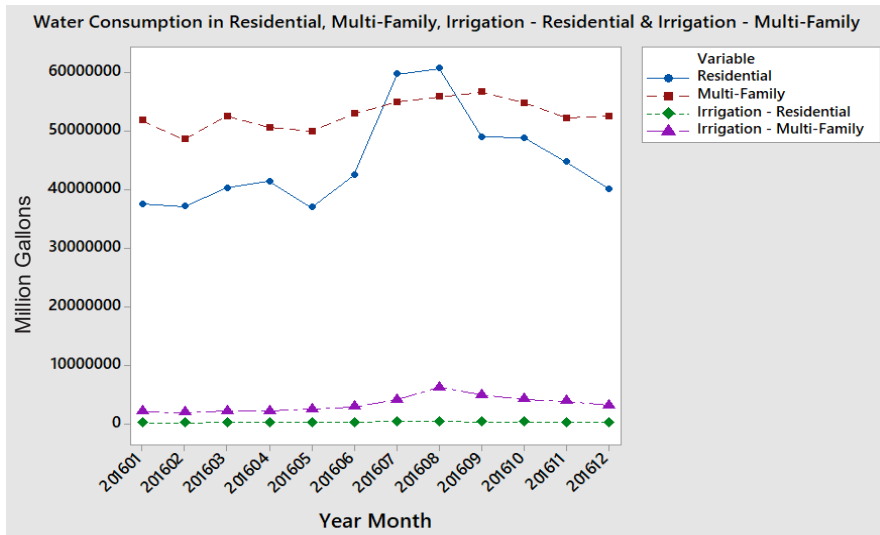

**Fig. 2.3: Monthly water consumption in Austin, USA, by different consumer classes**

Furthermore, a dataset from New Jersey was obtained (Fig. 2.4), which shows fresh-water use in different consumer sectors of other counties:

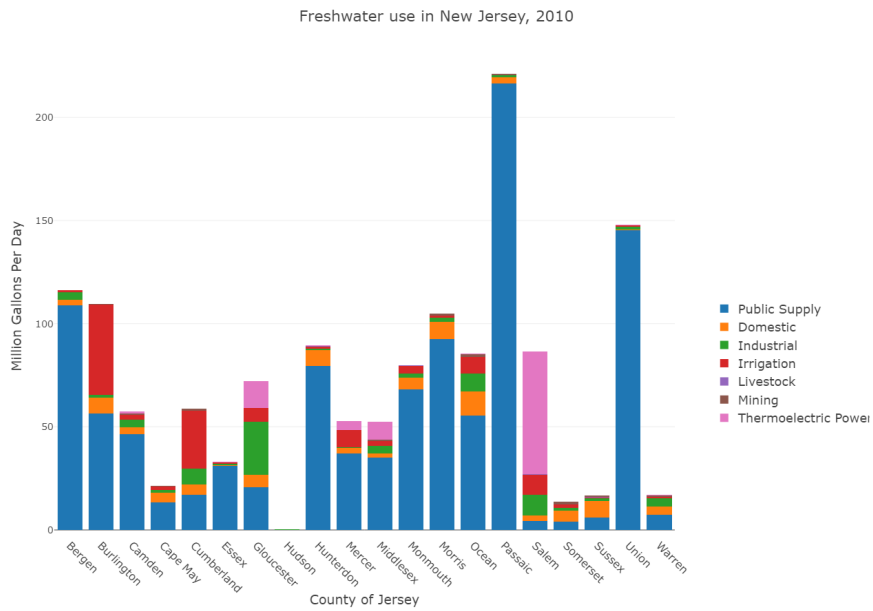

**Fig. 2.4: Daily water consumption by different consumer sectors in New Jersey, USA**

Expressed on monthly basis, Fig. 2.5 shows the domestic water consumption of New Jersey over eight years from 2010 to 2017.

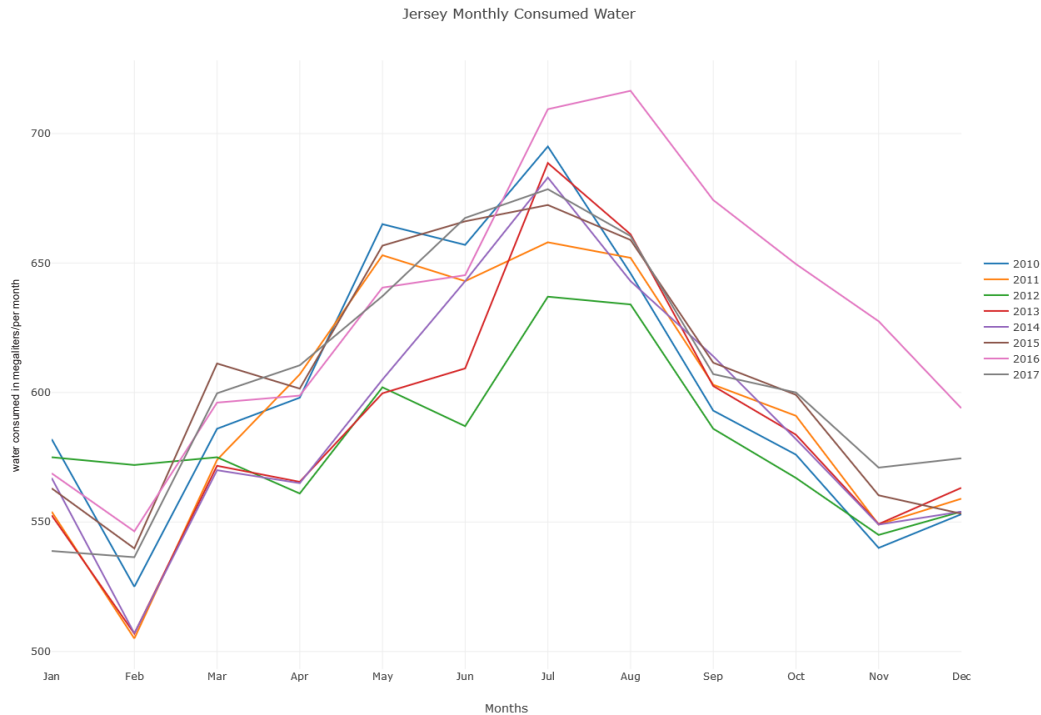

**Fig. 2.5: Monthly residential water consumption in New Jersey (2010 to 2017)**

## 2.2 Conceptual Modeling and Design

A conceptual model represents a system that is composed of concept used to help the modeler to know, understand, or simulate a subject that the model represents. To calculate water consumption at the household level, we proposed a hybrid modeling approach consisting of:

- Agent-Based Modeling paradigm**, which deals with the behaviour and characteristics of individual agent.
- System Dynamics (SD) paradigm**, which deals with fluid (water) flow dynamics.

A person consumes water in different activities. Every member of a house can do these water-consuming activities like using the toilet, taking a shower, faucet usage, etc. Similarly, the activities can be collectively done by a person for the whole house like washing clothes, outdoor use, kitchen use, etc. Due to this reason, water consumption activities are divided into two agents (1) Person and (2) House. An aggregate water consumption behavior emerges from the interactions of these agents, which can predict water consumption at any larger scale like block, neighborhood, city etc.

### 2.2.1 Person

In the model, a **person** consumes water as a part of water consumption activities (using the faucet, taking a shower, using the toilet) based on an activity occurrence probability and person's availability in the house. Household water will be consumed only if there is someone inside the house. The water consumption behavior of a person is shown by using the state chart in Fig. 2.6.

A person's presence depends on the type (employed or staying in the house) and the age group of the person. For example, infants remain in their homes throughout the day and hence utilize water. Children, however, who go to their schools, consume their household water once they are back from their schools. Similarly, teens go to their schools and colleges, and their unavailability duration is slightly greater than the children. On the other hand, adults need to spend most of their time outside to earn a living for their family. Elders are mostly retired people and spend most of their time in their houses, so their water utilization is more than other age groups. Table 2.1 shows the water consumption behaviour of different age groups based on their availability.

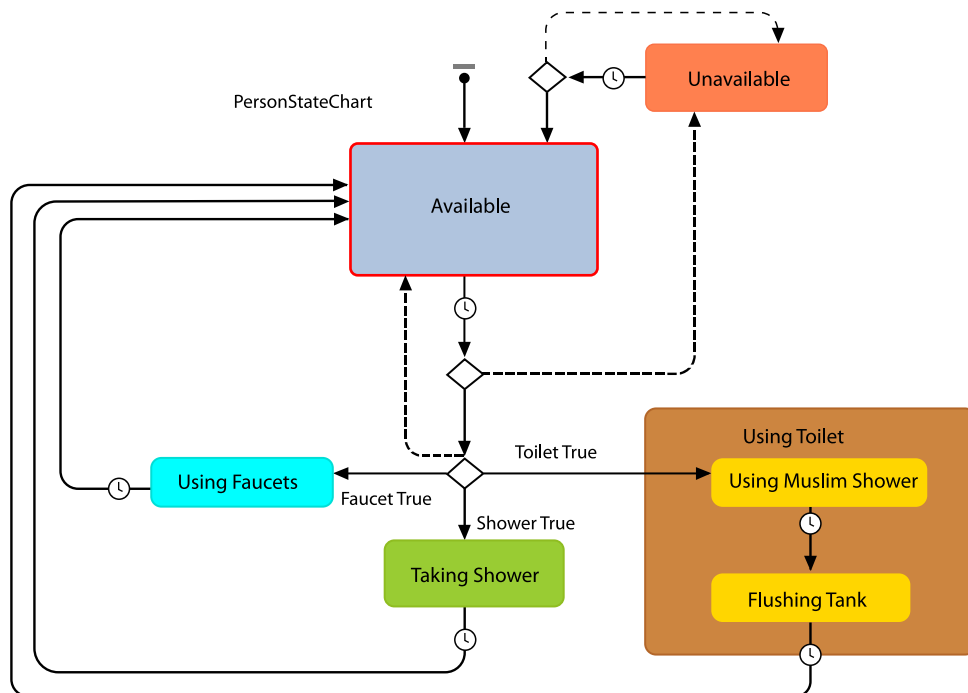

Fig. 2.6: State chart showing water consumption behavior of a person

**Table 2.1: Availability and water consumption behavior of different age groups**

Agent type	Availability	Behavior
Infant (1-5 yrs)	Mostly at home	Water consumption is carried throughout the day
Child (6-12 yrs)	Spend a small amount of time outside the house	Water consumption is comparatively less as compared to infants
Teen (13-19 yrs)	Spend half of their time in school or college	Water consumption only occurs once they are at home
Adult (20-59 yrs)	Spend most of their time in work-places	Water consumption is very low as compared to other age groups
Elders (60 and above)	Mostly retired persons and spend most of their time at home	Water consumption is highest compared to other age groups

### 2.2.2 House

A **house** contains people consuming water for activities involving kitchen, washing clothes, and outdoor usage. These activities assume active status based on the availability of a person in the house, a person’s willingness for water-use activity, and the occurrence probability of activity at a given time. The water consumption behavior of a house is shown by using a state chart in Fig. 2.7.

At whatever point a **person** or a **house** agent starts a water utilization activity, it causes withdrawal of water from the rooftop water tank to that movement repository for the period it remains in that action. House water flow using stocks and flows is shown in Fig. 2.8.

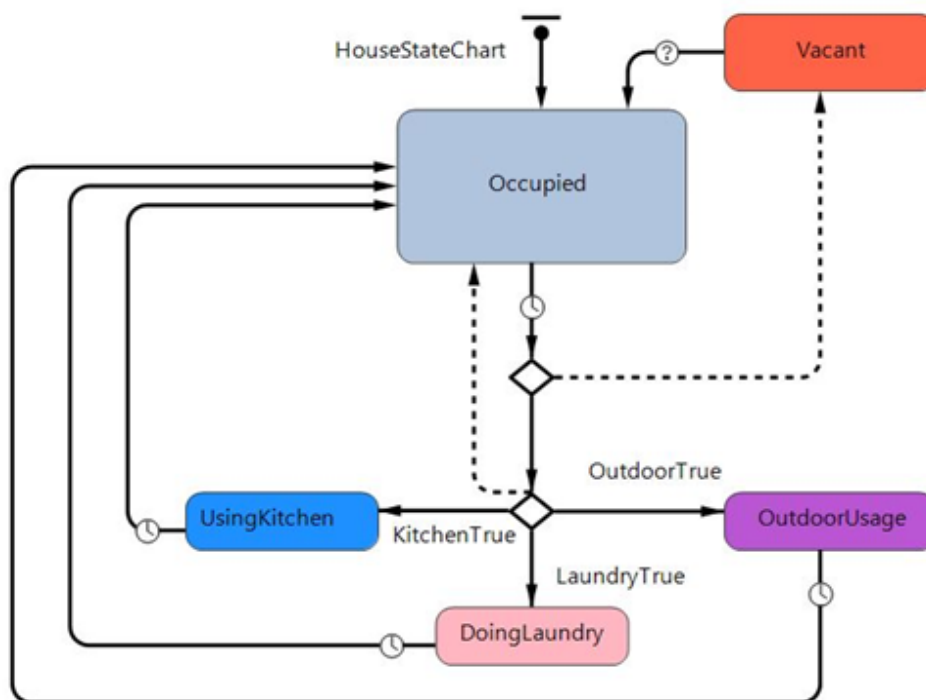

**Fig. 2.7: Water consumption behavior of a house**

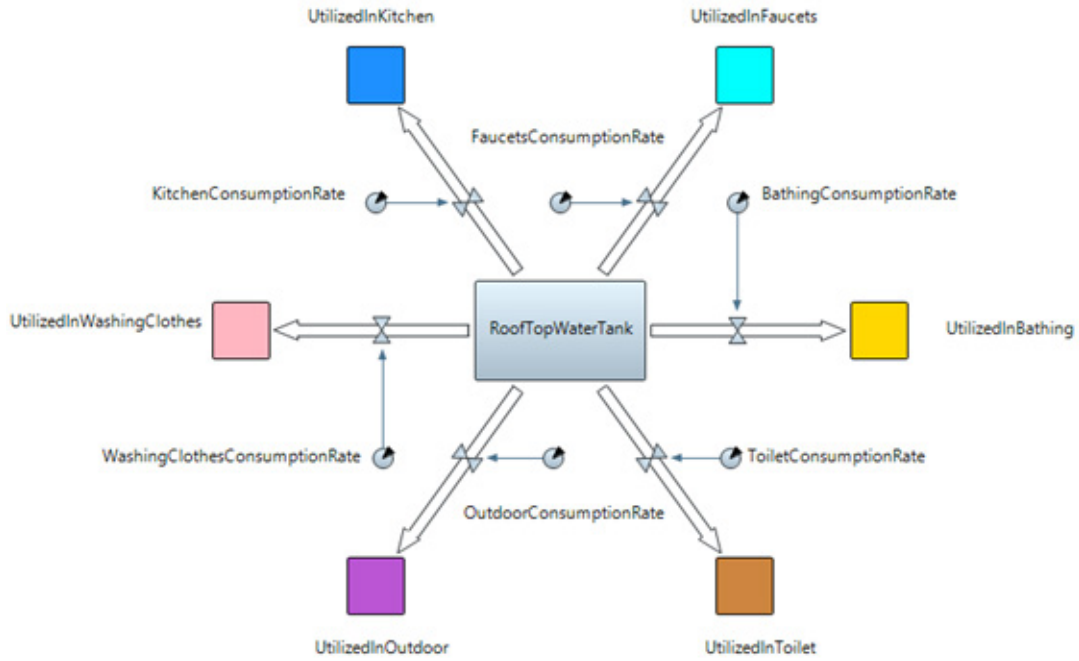

**Fig. 2.8: Water consumption behavior of a household showing stocks and water-flows**

### 2.2.3 Input data

Key inputs required to run the model are presented in Table 2.2.

**Table 2.2: Model input**

Model Parameters	Data input required
<b>Initial parameters</b>	No. of persons in a house/ apartment No. of apartments in a block No. of houses in a neighbourhood No. of blocks in a neighbourhood
<b>Probability of availability</b>	Infant, child, teen, adult, elder in a house/ apartment
<b>Probability of occurrence</b>	Use of kitchen, faucets, washing of clothes, bathing, toilet, and outdoor in 24 hours
<b>Activity duration</b>	Duration of water use in the kitchen, faucets, washing clothes, bathing, toilet, outdoor.
<b>Water consumption rates</b>	Kitchen, faucets, washing of clothes, bathing, toilet, outdoor

## 2.3 Model Implementation

The simulation modeling software used in this project is “Any Logic”, a holistic tool that provides adaptable Integrated Development Environment (IDE) for the analysis, testing, and optimization. Additionally, it supports three modeling techniques, Discrete Event, Agent-based and System Dynamics, and also allows hybrid modeling. It supports ready-to-use constructs and libraries for defining agent

behaviour, communication, environment models, and rich visualization capabilities. Moreover, Any Logic enables one to specify different parts of the model using different paradigms thus providing adequate modeling of large and complex systems.

This project used a hybrid approach that combines System Dynamics (SD) and Agent-based modeling (ABM). We have used Fluid Library (based on System Dynamics) to model water flow, while Agent-based modeling is used to model the water consumption behaviors of different agents.

The model consists of the following entities (Agents).

### 2.3.1 Person

A **person** is the main entity that consumes water in different activities.

#### 2.3.1.1 Input parameters

Input parameters of person are ID, person type (age groups like elder, adult, teen, child), availability probabilities, water consumption activities containing occurrence probabilities, consumption rates, and duration.

#### 2.3.1.2 State chart

A person can be in one of the five states in his/her lifetime.

- Available:** the presence of a person inside the house
- Unavailable:** the absence of a person from the house
- Using a faucet:** usage of a faucet for different usages like personal hygiene, wuzu
- Taking a shower:** usage of a shower for taking a bath
- Using toilet:** Toilet usage includes Muslim shower use and toilet tank flushing

Initially, every person is in an **available** state. After 15 min the availability of a person is checked using the availability probability of that age group. If the person is not available any more, it enters in the unavailable state, and after 15 min it re-evaluates the availability of the person to enter the available state. Suppose a person is available and there is a free washroom in the house. In that case, it can enter any water consumption activity, which opens the respective valves of the house fluid models to consume water. In water-consuming states, the person becomes dedicated to that state and can't show a willingness to do house level activities. The state chart indicating the behavior of the person is shown in Fig. 2.9.



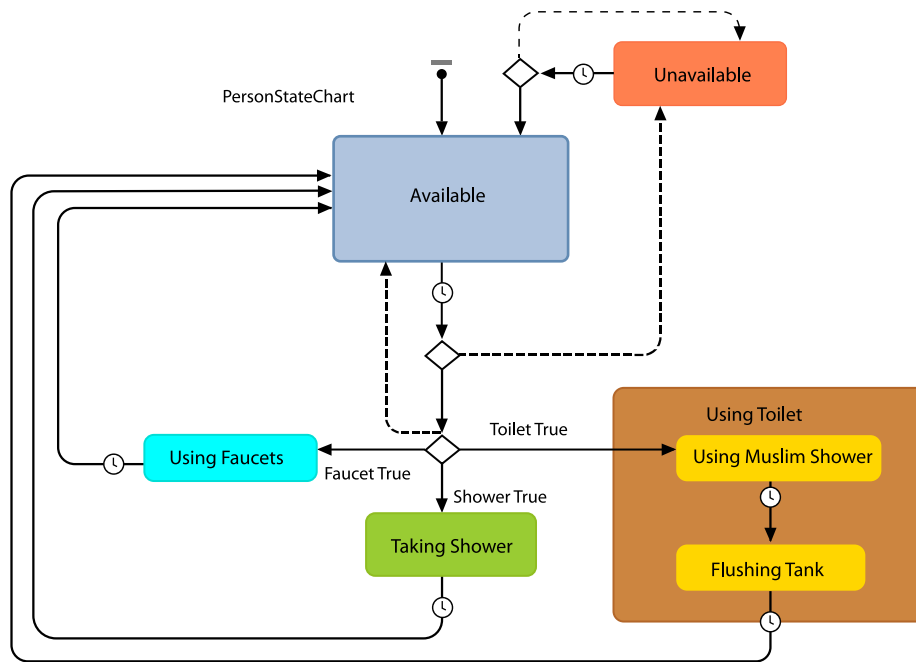

**Fig. 2.9: Behavior of a person in water consuming activities**

### 2.3.1.3 Washroom

In a washroom, different water consumption activities take place. These activities include showering, faucet use, and toilet use.

### 2.3.1.4 Fluid flow

The washroom contains a fluid flow structure with valves, faucet, shower, Muslim shower and toilet tank. Water is drawn from the valves when their respective water consumption activities are enabled. In the structure shown below, the fluid entry unit shows the entry of water to the washroom. S1, S2 and S3 are three splits, which divide the water evenly in the three valves. D1, D2, D3, and D4 are the disposal units, which show how much water is used by its particular valve. The fluid flow structure is shown in Fig. 2.10.

### 2.3.2 House

The **house** is a building with a variable number of rooms and has its own individual water storage tank in the real world. People from different age groups live together in a house, and due to variable composition and their water-use behavior, water consumption in different houses is different. Houses are defined as agents in the implementation of simulation.

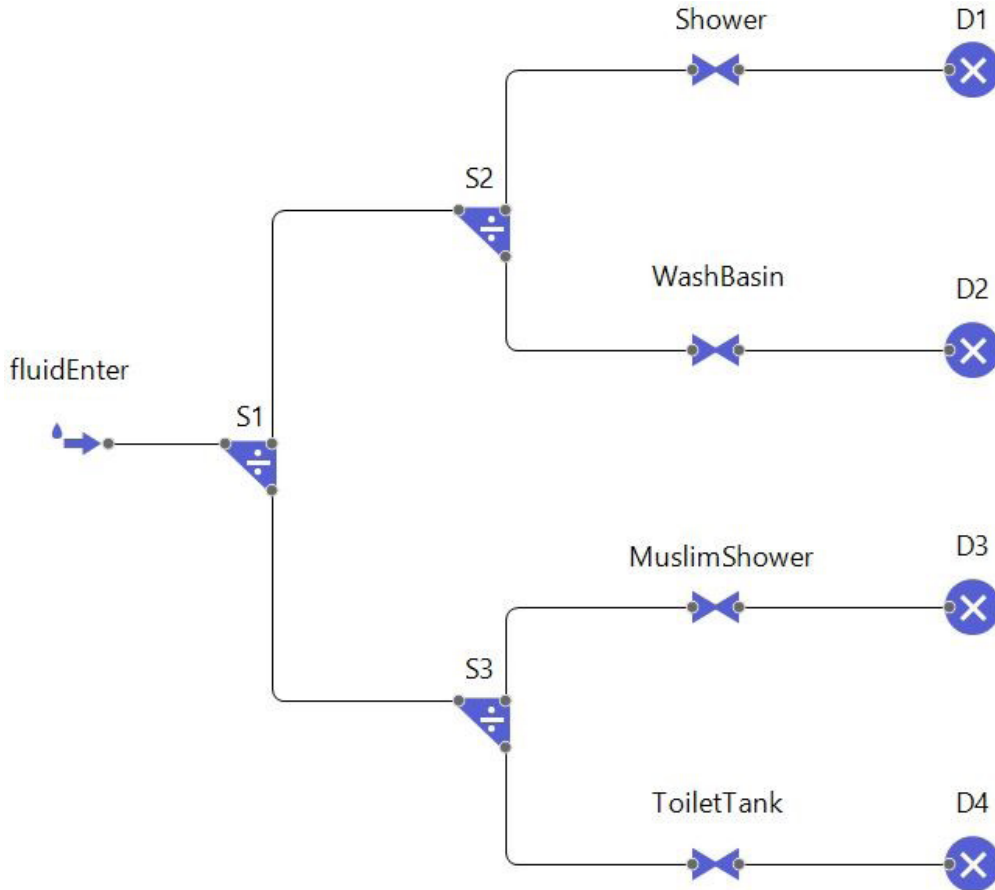

**Fig. 2.10: Washroom fluid flow structure**

### 2.3.2.1 Input parameters

Input parameters of a house are ID, number of occupants (persons), number of washrooms, capacity of water tank and water consumption activities with probability of occurrence, consumption rates and duration.

### 2.3.2.2 State chart

A house can be in one of the five states in its lifetime.

- **Occupied:** shows the presence of occupants in the house
- **Vacant:** shows absence of occupants in the house
- **Using kitchen:** shows water consumption in water activities like washing utensils, cooking
- **Outdoor usage:** shows outdoor water consumption like washing car, watering garden, cleaning
- **Doing laundry:** shows water consumption in clothes washing

Initially, the house is in the occupied state because all its inhabitants are available. After 15 min person presence is evaluated, the house enters the 'vacant' state if there is no one inside.

Otherwise, it will check if anyone is willing to do some water consumption activity and its occurrence probability. If both the conditions become true, it locks the person and enters into the water consumption activity. After finishing the activity, it releases the person and enters into an occupied state. The process then repeats itself. This behavior of house is implemented using a state chart shown in Fig. 2.11.

### 2.3.2.3 Fluid flow

A house contains fluid flow structure with its own water tank and different valves like kitchen, outdoor, laundry valve, and a washroom structure containing valves like a faucet, shower, Muslim shower, and toilet tank. Water is drawn from the valves when their respective water consumption activities are enabled.

In the structure shown in Fig. 2.12, the fluid entry unit shows water entry to the house tank.  $S_1, S_2, S_3, S_4, S_5, S_6, S_7,$  and  $S_8$  are eight splits, which divide the water evenly in three valves and four washrooms.  $D_1, D_2$  and  $D_3$  are the disposal units, which show how much water is used by a particular valve.  $E_1$  to  $E_6$  are the exit units. The fluid flow structure is shown in Fig. 2.12.

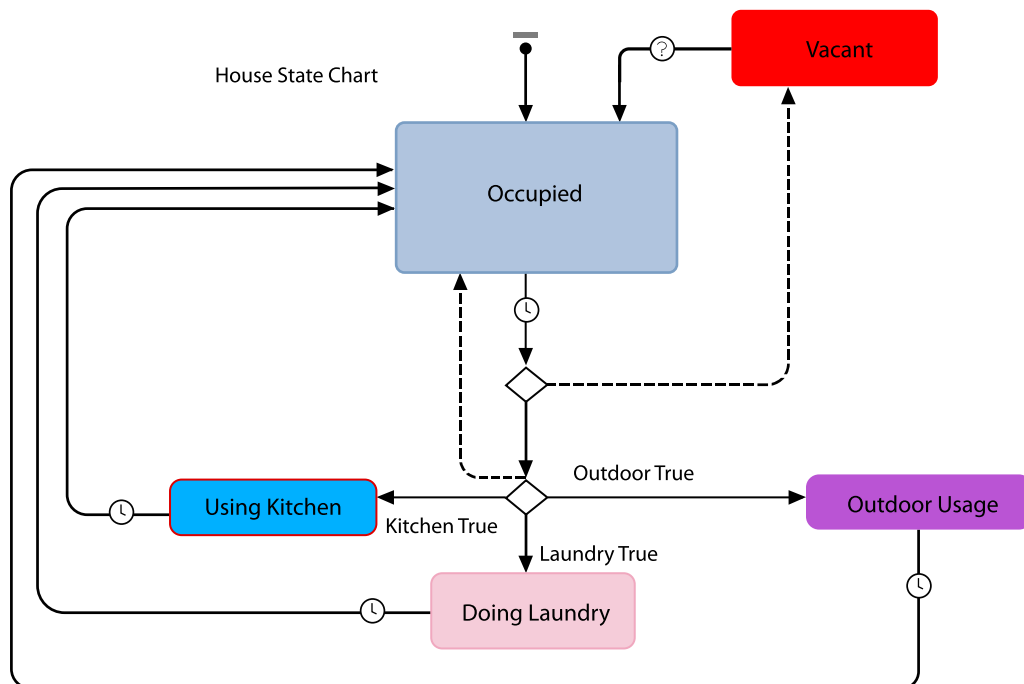

Fig. 2.11: Behavior of a house in water consuming activities

### 2.3.3 Apartment

In the real world, an **apartment** is a section of the block. It contains variable number of rooms but draws water from the water tank of the block. People of different age groups live together in it, and due to differences in their water use behavior, water consumption in different apartments is different. Apartments are defined as agents in the implementation of simulation.

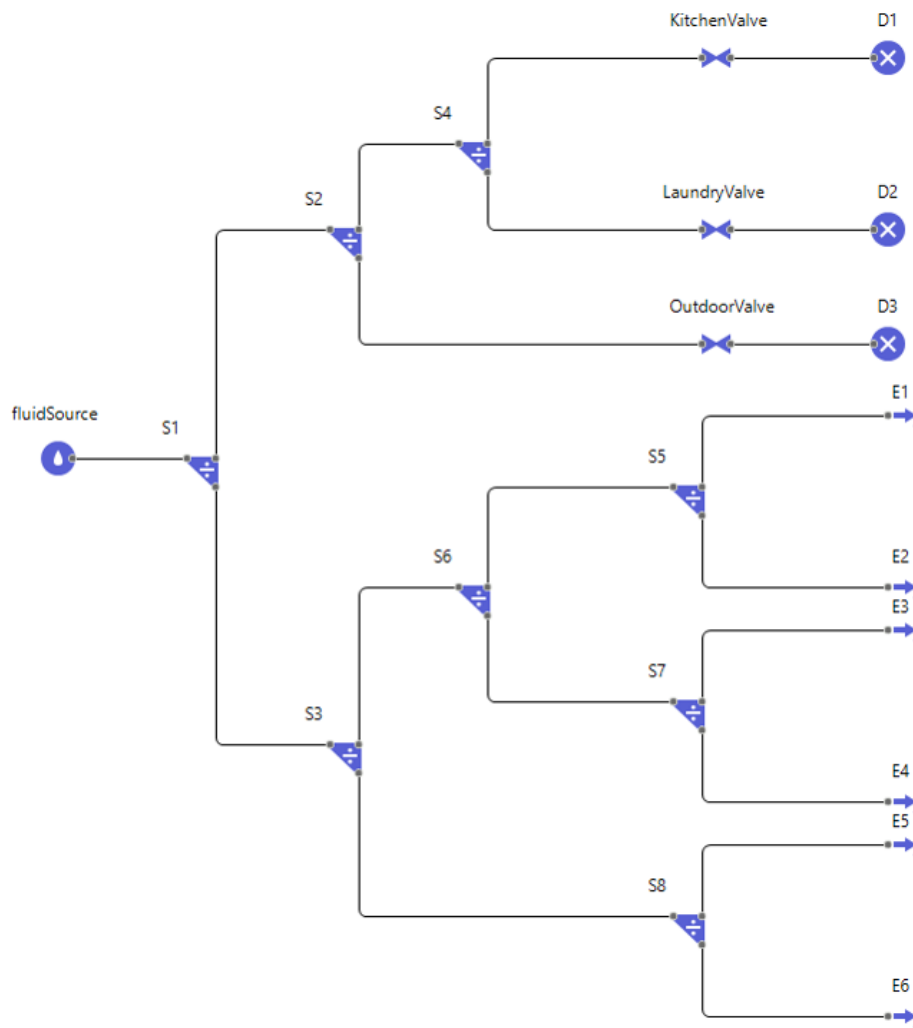

Fig. 2.12: Fluid flow structure of a house

### 2.3.3.1 Input parameters

Input parameters of an apartment are ID, the number of occupants (persons), number of washrooms and water consumption activities containing the probability of occurrence, consumption rates, and duration.

### 2.3.3.2 State Chart

An apartment can be in one of the five states in its lifetime.

- **Occupied:** shows the presence of occupants in the apartment
- **Vacant:** shows absence of occupants from the apartment
- **Using a kitchen:** shows water consumption in activities like washing utensils, cooking.
- **Outdoor usage:** shows outdoor water consumption like washing car, watering garden, cleaning.
- **Doing a laundry:** shows water consumption in clothes washing.

Initially, the apartment is in an occupied state because all its inhabitants are available. After 15 min person presence is evaluated, the apartment enters the 'vacant' state if there is no one inside. Otherwise, it will check if anyone is willing to do some water consumption activity of the apartment and its occurrence probability. If both the conditions become true, it locks the person and enters into water consumption activity. After finishing the activity, it releases the person and enters into the occupied state. The process then repeats itself. This behavior of apartment is implemented using a state chart given in Fig. 2.13.

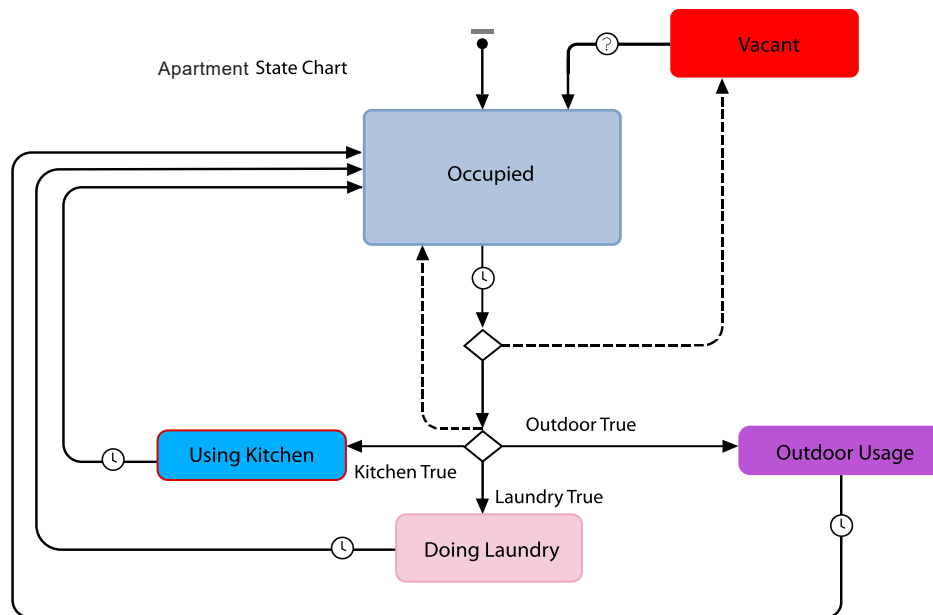

**Fig. 2.13: Behavior of an apartment in water consuming activities**

### 2.3.3.3 Fluid flow

An apartment contains a fluid flow structure, which lacks its own water tank and draws water from the water storage of its block. It also has different valves like kitchen, outdoor, laundry valve and washroom structure containing valves like a faucet, shower, Muslim shower, and toilet tank. Water is drawn from the valves when their respective water consumption activities are enabled.

In the structure shown in Fig. 2.14, the fluid entry unit shows water entry to the apartment tank.  $S_1, S_2, S_3, S_4, S_5, S_6$  and  $S_7$  are seven splits which divide the water evenly in three valves and four washrooms.  $D_1, D_2$  and  $D_3$  are the disposal units that show how much water is used by its particular valve.  $E_1$  to  $E_5$  are exit units.

### 2.3.4 Block

Block is a building containing a different number of apartments. The water consumption behavior of a single apartment forms an emergent behavior to study water consumption.

### 2.3.4.1 Input parameters

Input parameters of a block are ID, name, site, number of apartments, capacity of the water tank and water consumption activities containing the probability of occurrence, consumption rates, and duration.

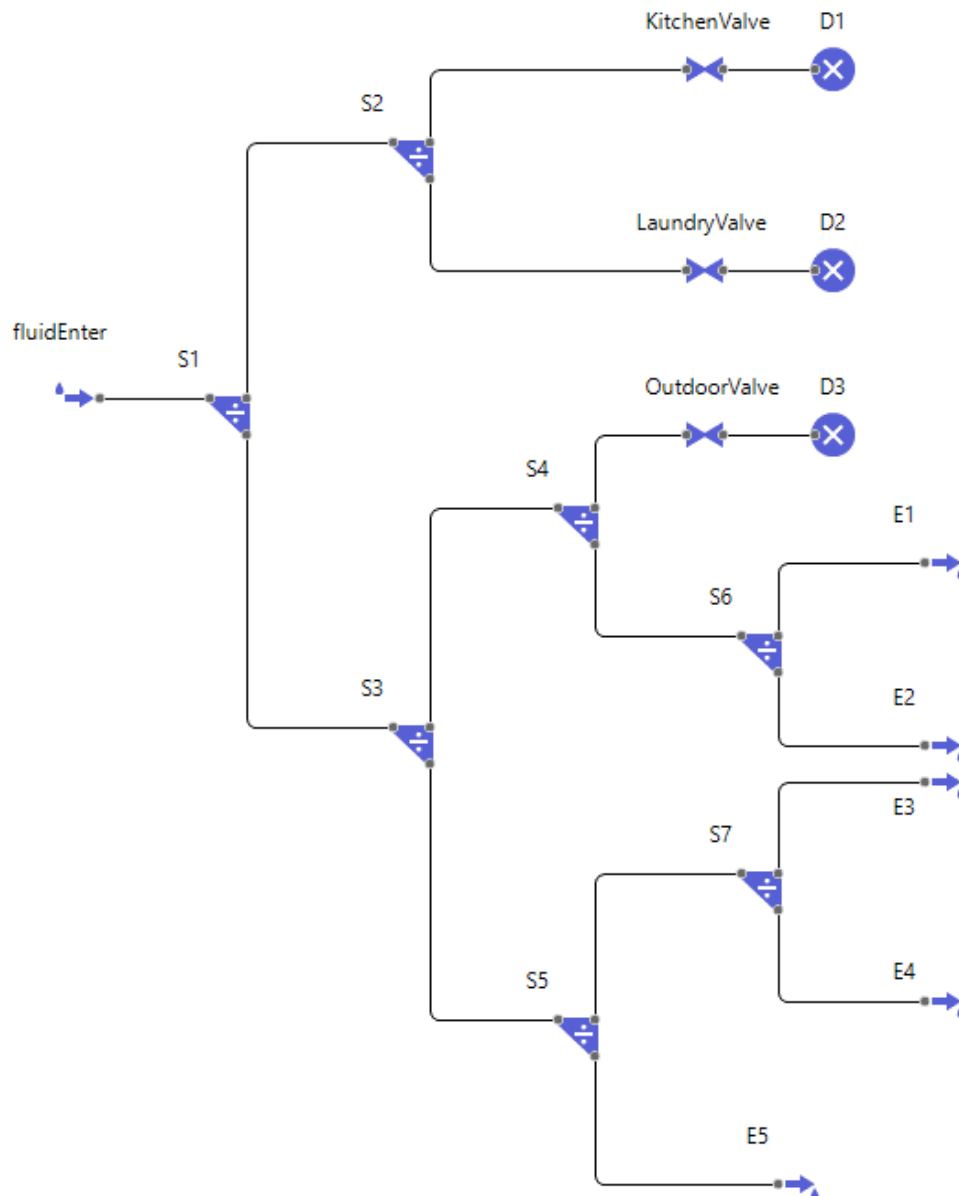
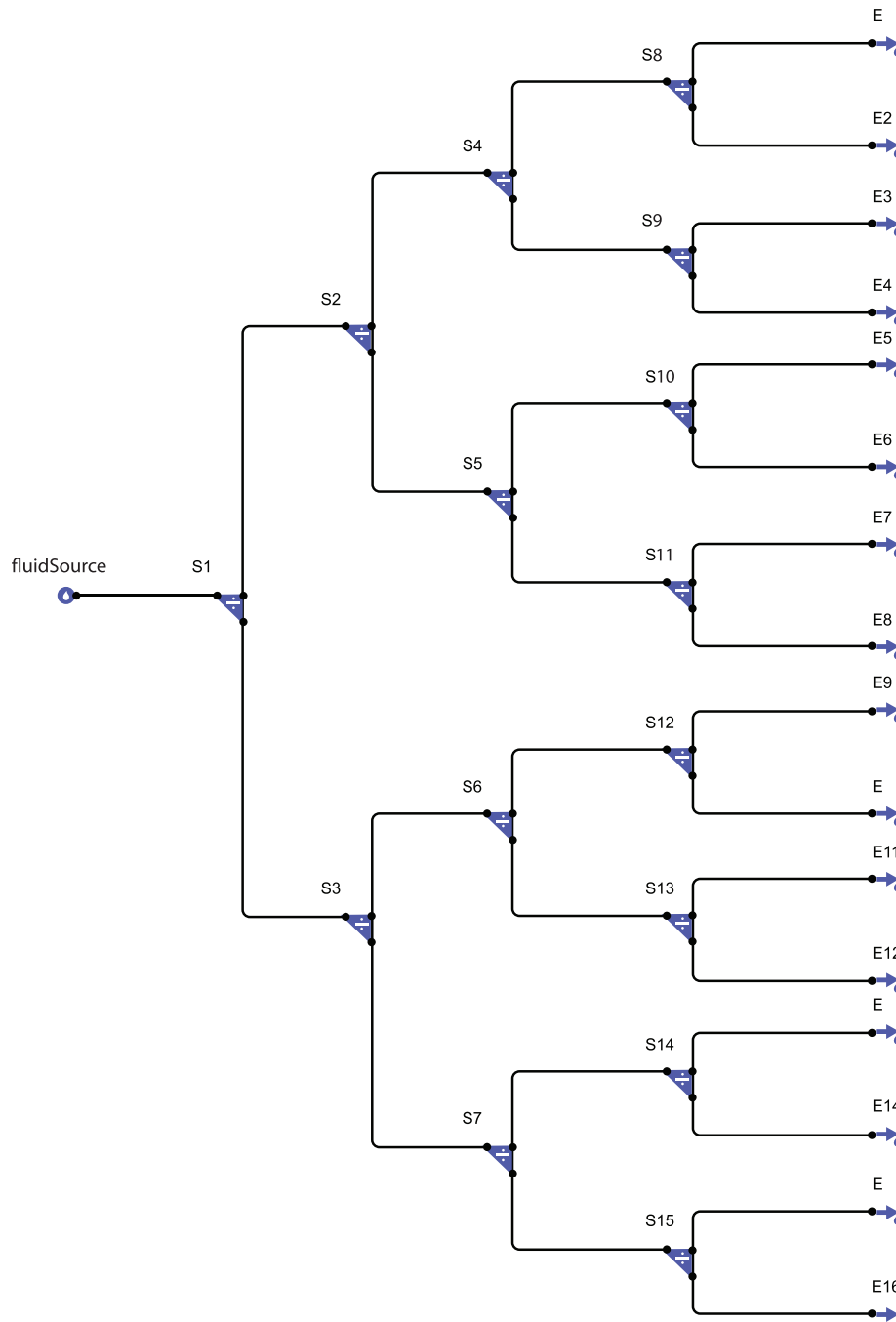

Fig. 2.14: Fluid flow structure of an apartment

### 2.3.4.2 Fluid flow

A block contains its own water tank, and its apartments draw water from it. In the structure shown in Fig. 2.15, the fluid entry unit shows water entry to the block tank.  $S_1$  to  $S_{15}$  are fifteen splits, which divide the water evenly to 16 valves connected to 16 exits ( $E_1$  to  $E_{16}$ ) for water supply to 16 apartments. The fluid flow structure of a block is given in Fig. 2.15.



**Fig. 2.15: Fluid flow structure of a block**

### 2.3.5 Neighbourhood

A neighbourhood is a collection of houses and blocks. Their collective water consumption behavior can help in gaining insight into the water consumption trends of a region.

#### 2.3.5.1 Input parameters

Input parameters of a neighbourhood are ID, name, number of blocks, number of houses, and location.

### 2.3.6 Database

A database is used to store data for the initialization of agents and water consumption data. Entities used in the model are given below along with their purpose. The parameters used in the model are listed in the entity relationship diagram (Fig. 2.16).

1. **Activities:** used to initialize activities in the model
2. **Houses:** used to initialize house parameters and populate the number of washrooms
3. **Blocks:** used to initialize block parameters
4. **Apartments:** used to initialize apartment parameters, assign apartment to its block, and populate its washrooms
5. **Population house:** used to populate persons in their respective houses
6. **Population apartment:** used to populate persons in their apartments

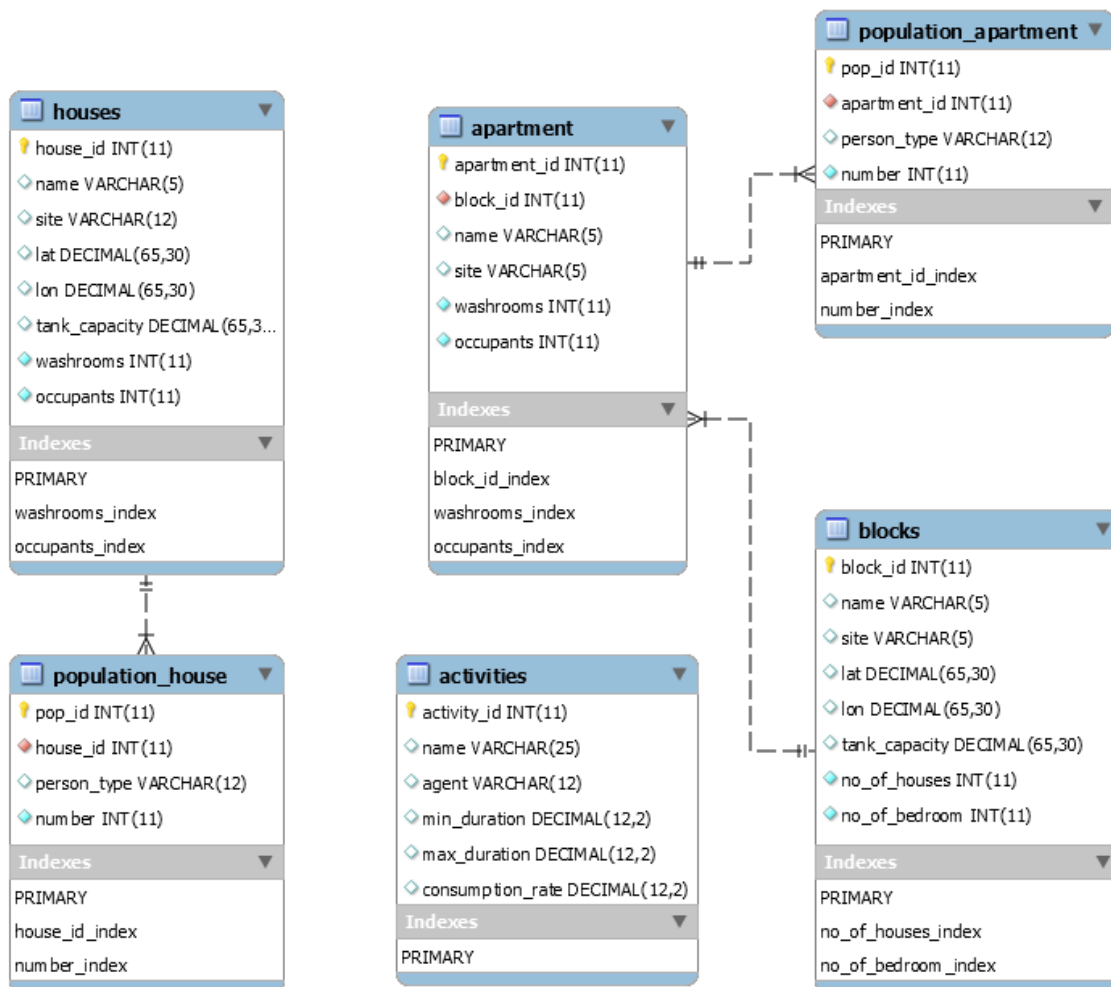

Fig. 2.16: Entity relationship diagram



### 2.3.7 Case Study

The above agents were used to simulate the demand side (House Hold) in NUST, Main Campus, H-12, Islamabad.

In NUST, the total population is 1038 living in the residential area, which contains 22 Villas and 27 blocks. Houses and blocks of NUST are divided into two sites. Site 1 has Grid and IQRA Apartments containing 2 and 8 blocks, respectively. Site 2 has ISRA Apartments (containing 17 blocks) and 22 NUST villas. The information about the residential area is given in Table 2.3.

**Table 2.3: Data of the residential area of NUST**

Buildings	Number	Washroom	Water tank capacity (Gln)	Occupants
NUST Villa (1-8)	8	6	1800	3 - 5
NUST Villa (9-22)	14	5	1800	2 - 8
GRID Apartment (GSA)	4 Apartments/block	5	6000	3 - 5
GRID Apartment (GSB)	6 Apartments/ block	2	4000	3 - 6
IQRA Apartment (R,S,T,U)	8 Apartments/block	1	2000	1 - 2
IQRA Apartment (V,W,X,Y)	8 Apartments/block	2	2000	2 - 3
ISRA Apartment (B, C, D, E)	8 Apartments/block	5	6000	3 - 10
ISRA Apartment (F, G, H, J)	12 Apartments/ block	2	9000	3 - 7
ISRA Apartment (K, L, M, N)	8 Apartments/block	2	4000	3 - 8
ISRA Apartment (LL, KK)	16 Apartments/ block	2	15000	2 - 6
ISRA Apartment (O, P, Q)	8 Apartments/block	1	4000	2 - 8

The trend of water consumption activities inside NUST is shown in Fig. 2.17, while the data on the trend of person availability inside NUST is revealed in Fig. 2.18.

### 2.3.8 Simulation

A 2D simulation dashboard of the NUST case study is given in Fig. 2.19. It contains a GIS map on which houses and blocks are located at their GIS locations using latitude and longitude. GIS map can be scaled up and down by scrolling up and down. Other locations of the map can be explored by grip and drag.

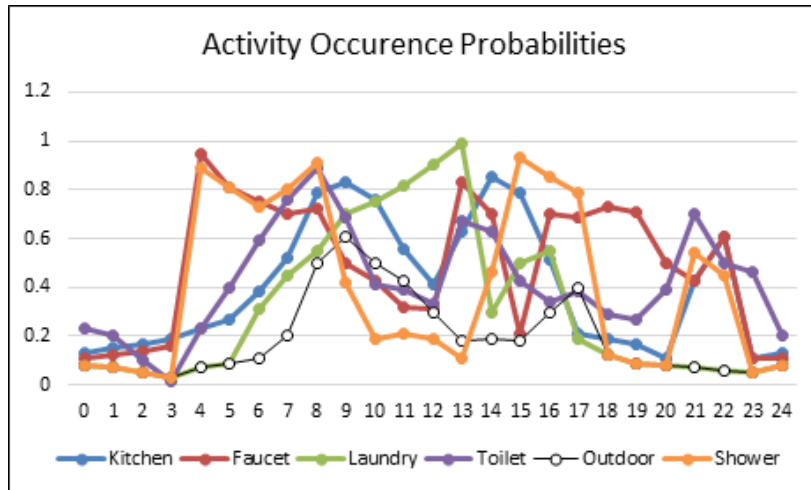

Fig. 2.17: The trend of water consumption activities inside NUST

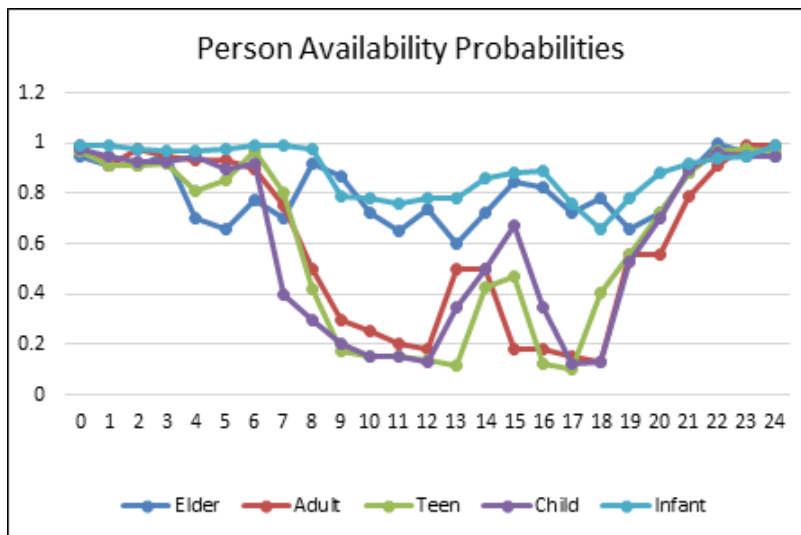

Fig. 2.18: The trend of person availability inside NUST

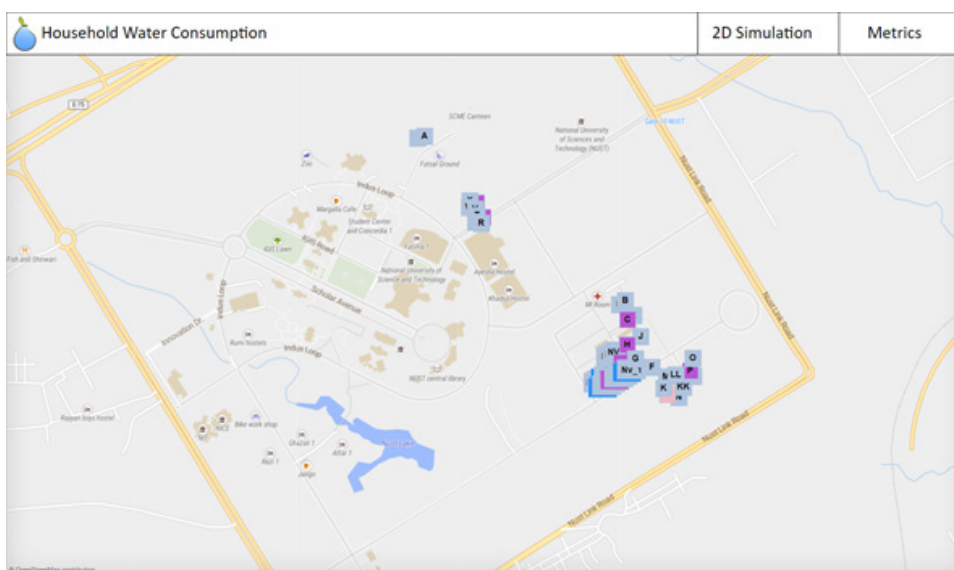

Fig. 2.19: 2D simulation dashboard of the NUST case study

A scale-up picture of the map (Fig. 2.19) is given in Fig. 2.20. Rectangular shaped structures denote NUST Villas (Houses) with their name written on them. Squares are apartments stacked over each other to form block representation, and the name of the block is written over them.

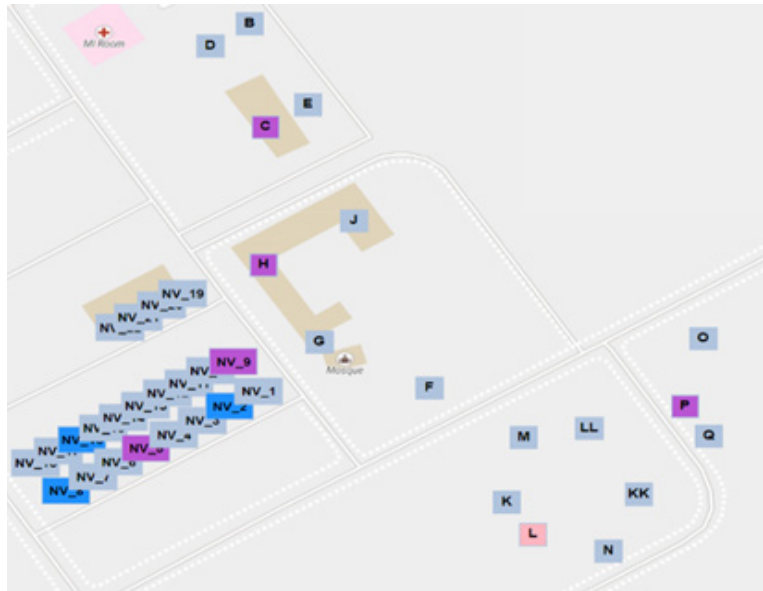

Fig. 2.20: NUST Villas & ISRA Apartments

### 2.3.8.1 House

The simulation result of one house (NUST Villa 1) is presented in this section. It is depicted through parameters, variables, functions and behavior of the house in Fig. 2.21 and that of the first person from the population of persons residing in the above house in Fig. 2.22.

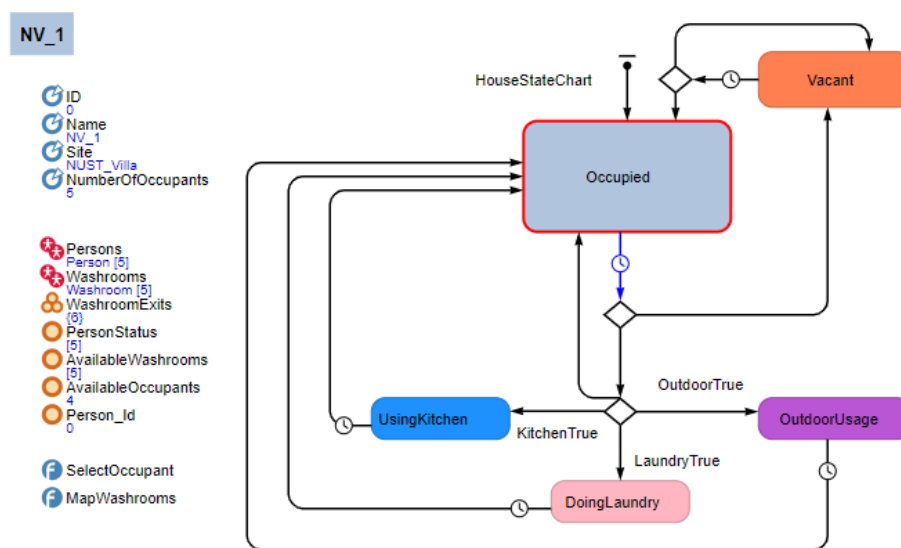
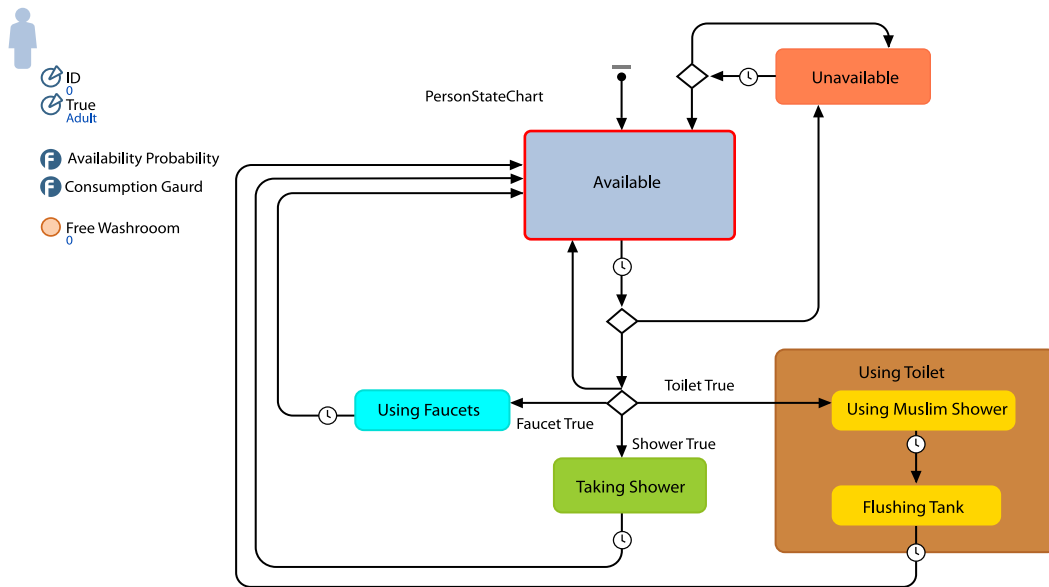

Fig. 2.21: Parameters, variables, functions and behaviour of the house agent



**Fig. 2.22: Parameters, variables, functions and behaviour of a person agent**

Fluid flow inside the house is shown in Fig. 2.23 that contains five washrooms connected by fluid exits E1, E2, E3, E4, and E5. One of the washrooms is displayed in the picture.

### 2.3.8.2 Block

The simulation result of one block (LL with 16 apartments) is presented in this section. Fig. 2.24 and 2.25 respectively show parameters, variables, functions and behavior of an apartment (LL-8) of block LL and first person from the population of persons of the above apartment.

Fig. 2.26 shows the fluid flow inside the block containing 16 apartments with two washrooms per apartment. One of the apartments (LL-8) and one washroom is displayed in the picture.

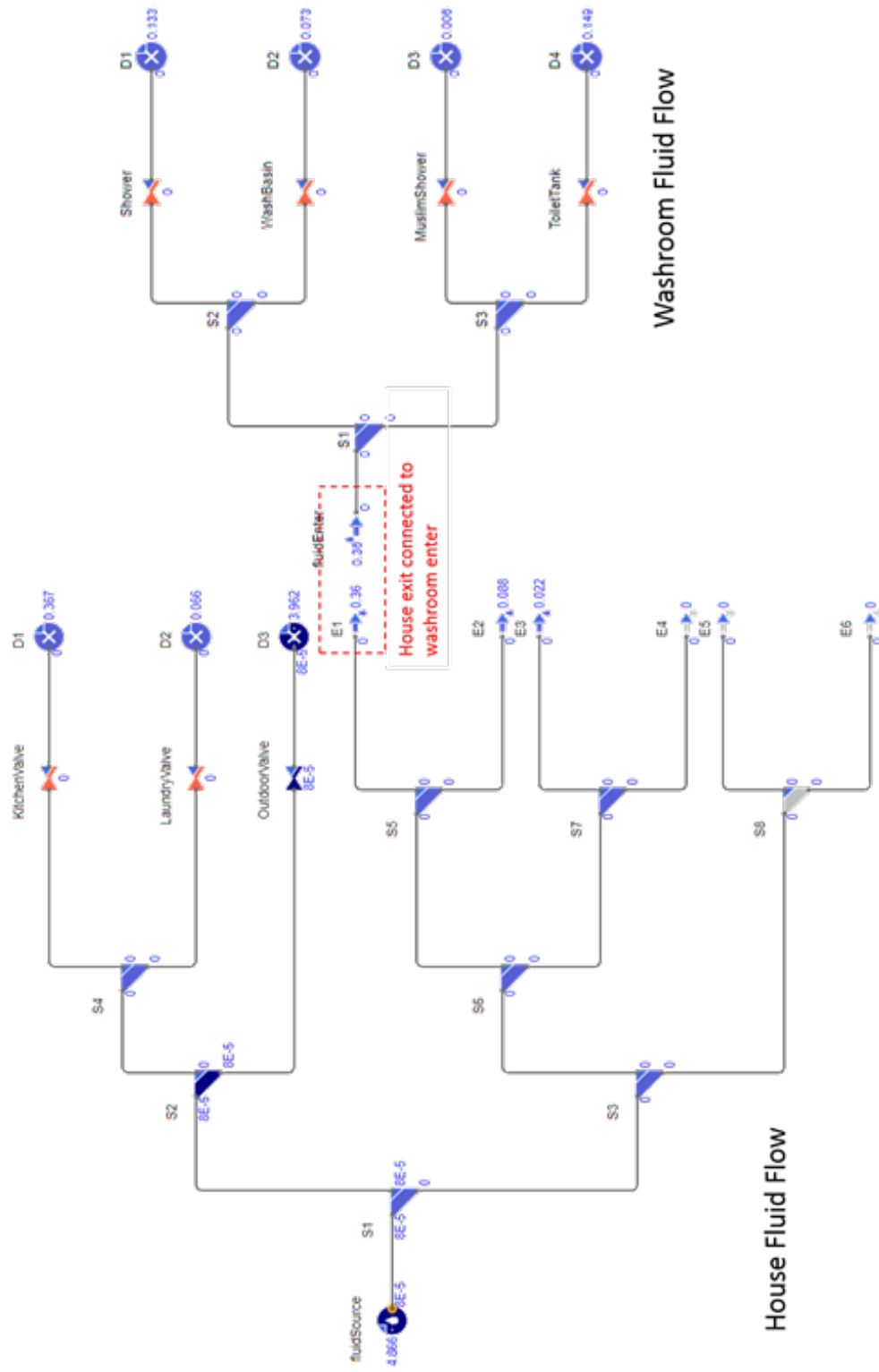

Fig. 2.23: House fluid flow structure with washroom fluid flow

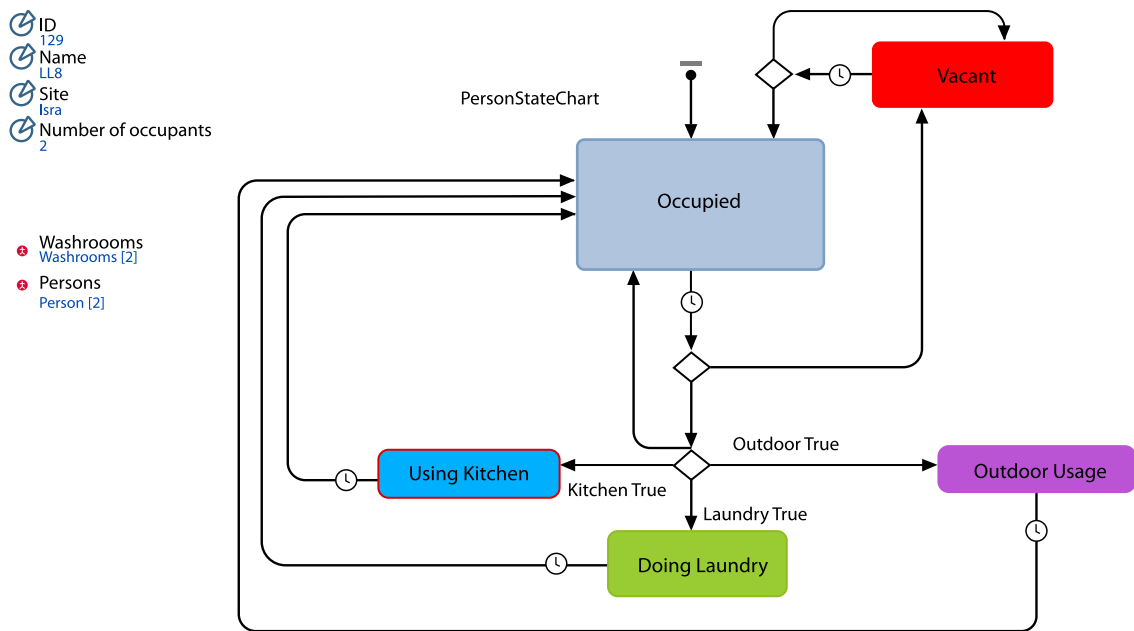

Fig. 2.24: Parameters, variables, functions and behaviour of an apartment agent

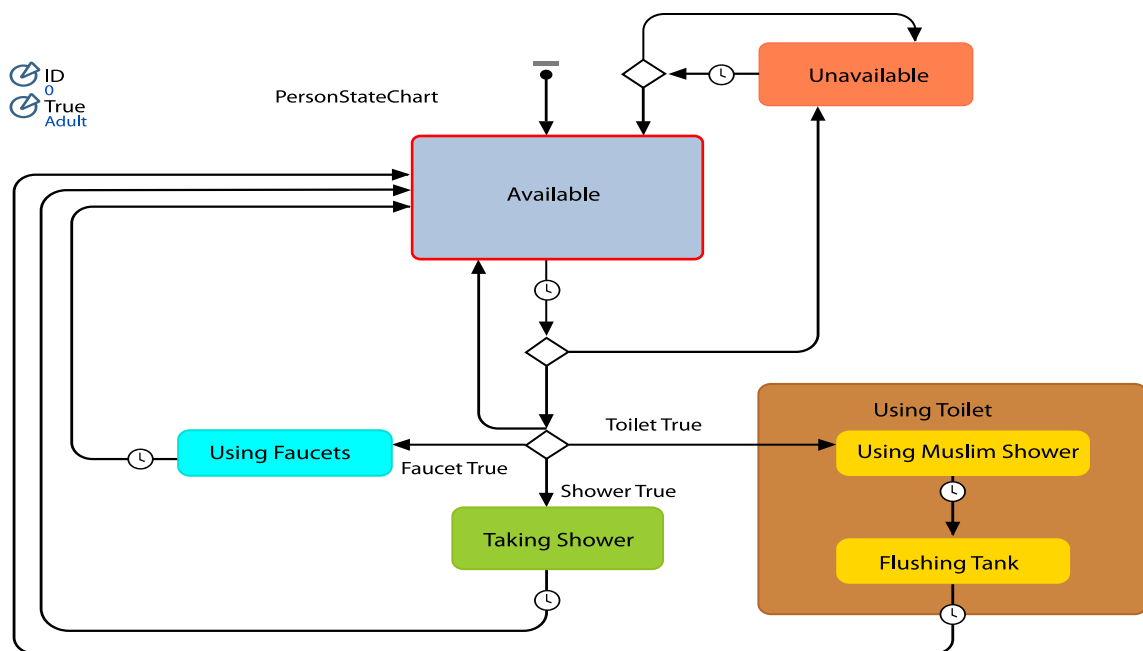
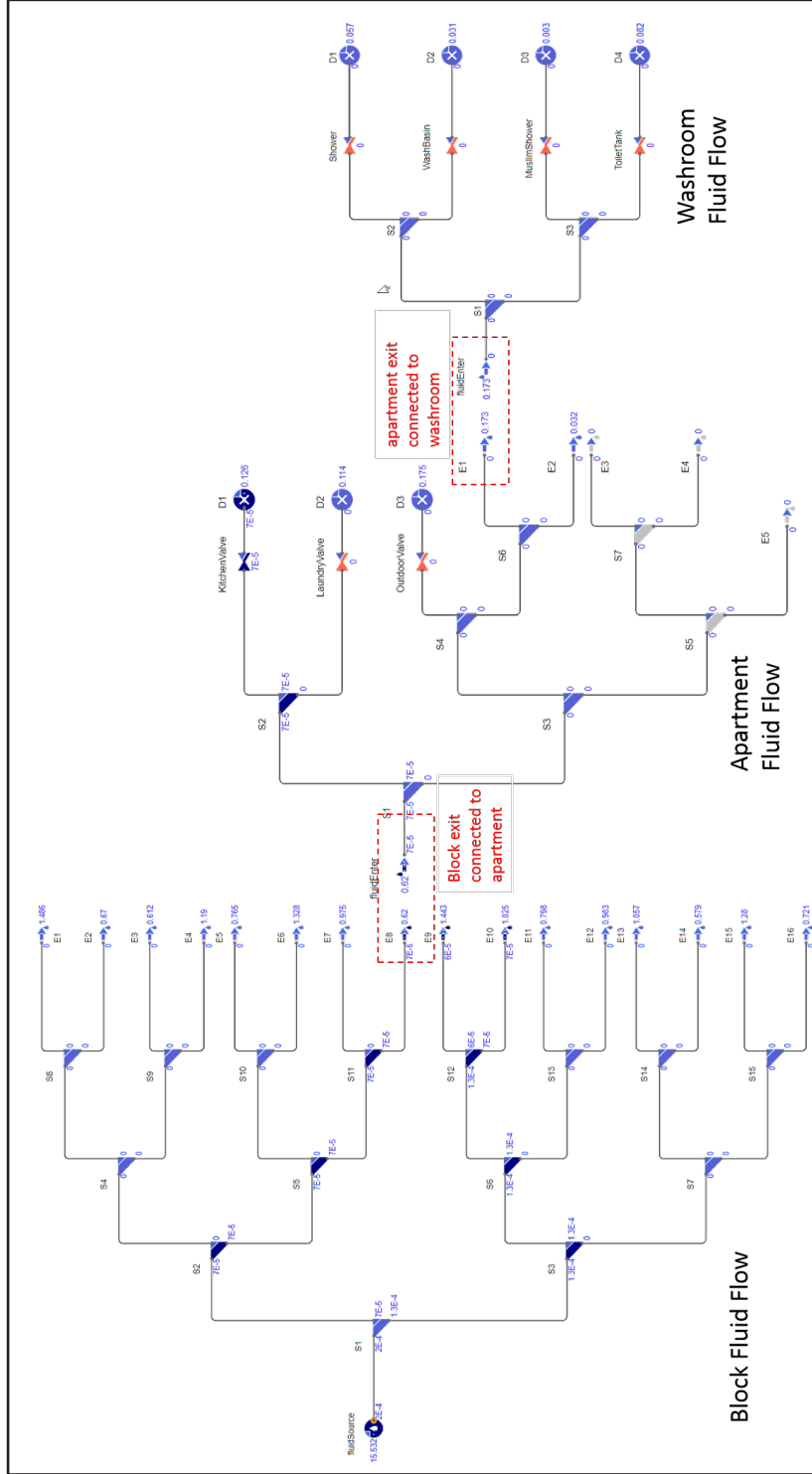

Fig. 2.25: Parameters, variables, functions and behaviour of a person agent



LL

ID 13  
 Name LL  
 Site Isra  
 apartments Apartment [16]  
 exits {16}

Fig. 2.26: Block fluid flow structure

## 2.4 IoT Kit Development

The Internet of Things (IoT) is the network of interrelated objects, animals or people provided with the ability to transfer and share data over a network without requiring human-to-human or human-to-computer interaction.

As a part of this study, IoT Kit is developed to calculate water consumed by each activity in a house. These data will then be used for calibration and validation of the simulation model. Existing non-invasive approaches are costly. Invasive techniques are cheap, but it's not wise to install invasive systems on each tap. Therefore, we proposed an economical and easy to implement technique to achieve the goal. The architectural diagram of the IoT Kit is given in Fig. 2.27.

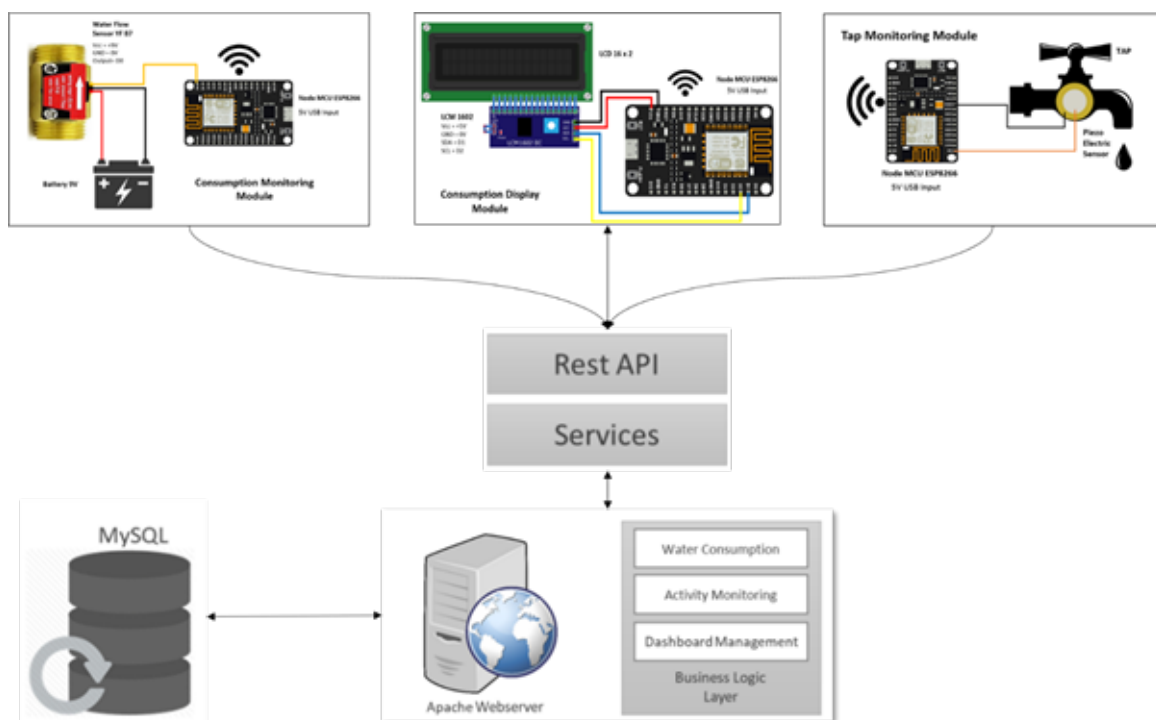

**Fig. 2.27: Hardware architectural diagram of the IoT Kit**

Different modules of the IoT Kit are discussed below in detail.

### 2.4.1 Consumption monitoring module

The consumption monitoring module, shown in Fig. 2.28, is used to calculate the water consumption of a house using water flow sensors and send this data to the server. Installed in the supply pipe of the house near the water tank, it sends data containing house id, duration in sec and pulses generated by flow sensor to the server whenever water flows in the pipe.



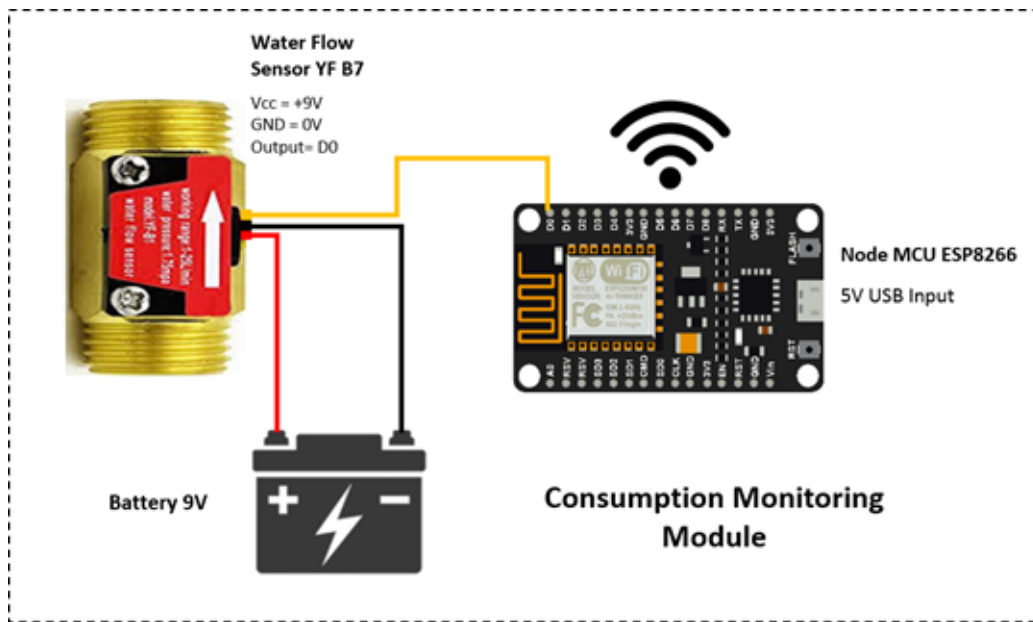

**Fig. 2.28: Circuit diagram of the consumption monitoring module**

The consumption monitoring module consists of the following electrical components:

#### **2.4.1.1 Water flow sensor**

The water flow sensor YF-B7 (Fig. 2.29) consists of a rotating fan and a Hall effect sensor to measure a change in the consumption rate. It is small, cheap, and easy to install. It requires intrusion into the water pipe as it needs contact with water to measure water flow. When the flow rate of water passing through the sensor changes the speed of the rotating fan also changes, so the pulse frequency generated by the Hall effect sensor is given to NodeMCU.



**Fig. 2.29: Water flow sensor**

The water flow sensor usually operates at 5-24V DC input voltages. The output pin of this sensor must be set high initially to identify the pulses.

### **2.4.1.2 NodeMCU**

NodeMCU is an open-source platform, which consists of an ESP8266 Wi-Fi-enabled chip. The ESP8266 is a low-cost Wi-Fi chip developed by Espressif Systems with TCP/IP protocol. NodeMCU has Arduino like analog (A0), and digital (D0-D8) pins on its board (Fig. 2.30).

The pulses from a water flow sensor are supplied to the digital pin of NodeMCU where it adds up. After the water consumption period ends, it sends the pulses to the server along with house id and duration in seconds.

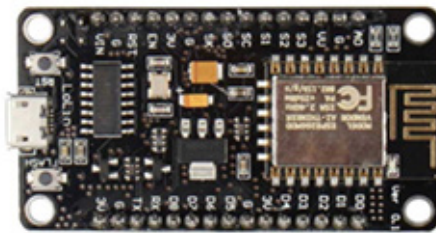

**Fig. 2.30: NodeMCU**

### **2.4.1.3 Consumption monitoring module calibration**

The consumption monitoring module is installed in the supply pipe of the house near the water tank. It gives different pulses for different taps of the house for the same amount of water. It is because of varying flow rates through the sensor caused by different sizes of taps outlet. To resolve this problem, we needed several pulses per litre of each tap. In this regard, we prepared a smart jug to get multiple readings of pulses per litre of the tap and calculated pulses per litre of the tap to measure the amount of water used by the particular tap.

### **2.4.1.4 Tape calibration measurement module**

Fig. 2.31 shows the tap calibration measurement module. Following are the components of the tap calibration measurement module.

#### **i. Water flow sensor**

The water flow sensor YF-B7 consists of a rotating fan and a Hall effect sensor to measure the change in the consumption rate. It is installed in the supply pipe of the house near the water tank.

#### **ii. Smart jug**

The smart jug is a plastic 8L measuring jug in which wires are attached at different levels. A wire with +5V is placed at the bottom (0L), and the other wires at 1L, 2L, 3L, 4L, and 5L are connected to a 10-ohm resistor attached to the Analog pins of the Arduino Mega. When water is added to the jug and its level reaches 1L, one circuit completes. Similarly, if water keeps on adding, other circuits also become complete.

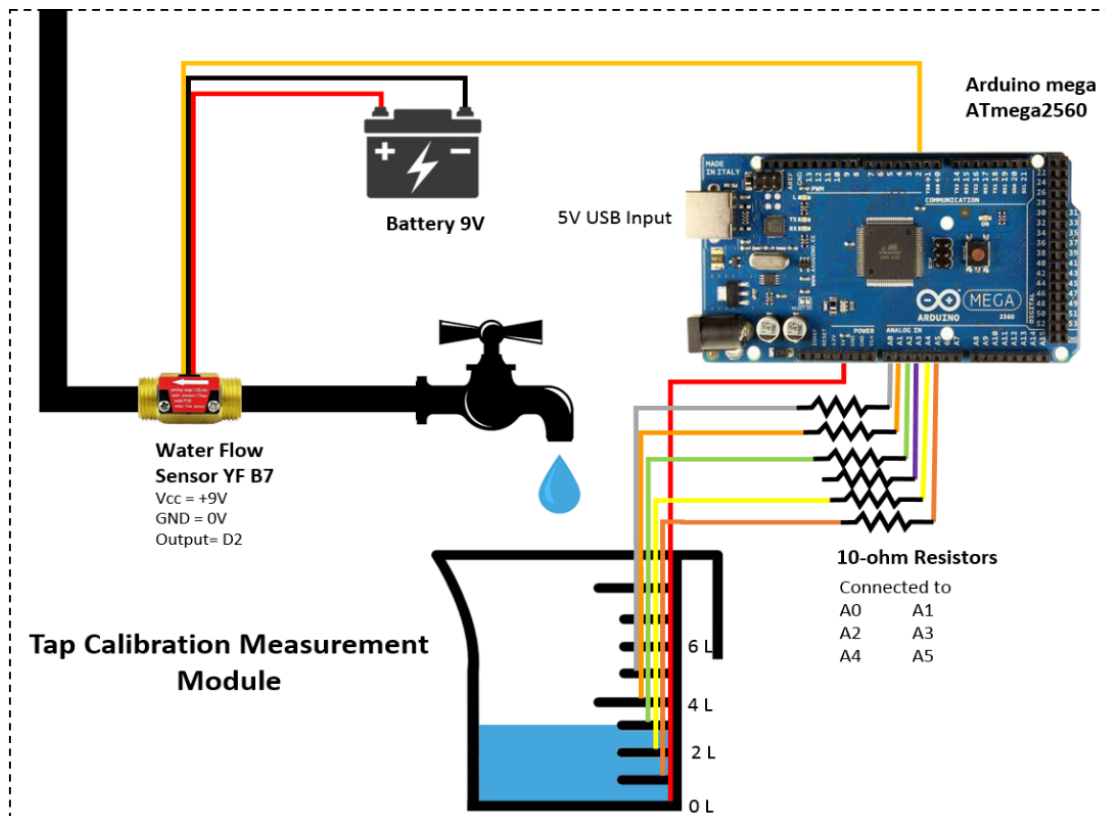

**Fig. 2.31: Tap calibration measurement module**

### iii. Arduino Mega 2560

Arduino Mega 2560 is simple in use and easily available. It provides large numbers of digital pins, analog pins, and communication pins. It has an onboard ATmega2560 microcontroller in which code is burned. It has a large memory of 256 KB to store the program. Arduino Mega has a code that saves time and pulses of water flow sensor whenever any circuit is completed in the above circuit. In short, it records the time and pulses of 1 L water drawn from a tap.

### 2.4.2 Tap monitoring module (A)

The tap monitoring module uses a piezoelectric sensor to detect the on/off status and the 'on' state duration. It is placed on each tap of the house (Fig. 2.32). It sends data containing tap id, house id, and duration to the server on the completion of water activity sensed through vibration in the tap.

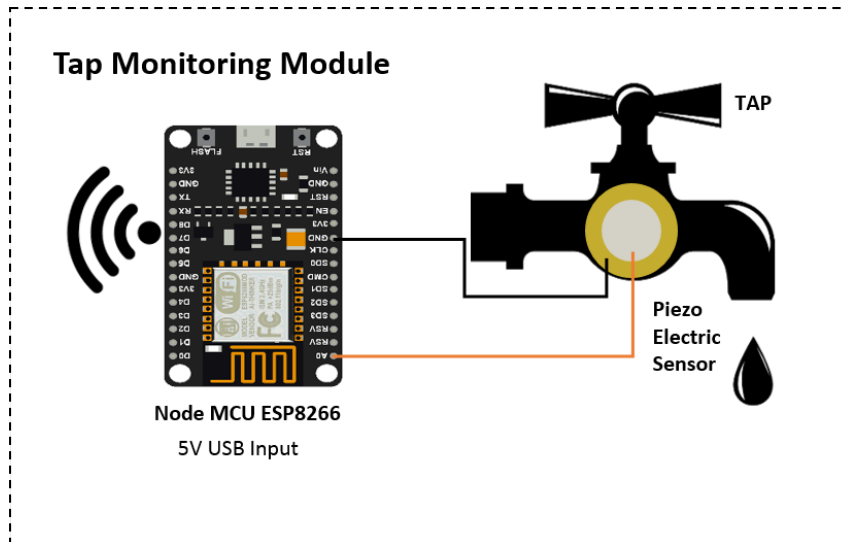

**Fig. 2.32: Circuit diagram of the tap monitoring module (A)**

The electrical components of the tap monitoring module are given below.

#### **2.4.2.1 Piezoelectric vibration sensor**

The piezoelectric plate is a transducer, which converts mechanical energy into electrical energy. The piezoelectric vibration sensor (Fig. 2.33) is fitted on the top of each tap to detect the tap's on/off status. When the user switches on the tap, the piezoelectric sensor will detect the water-induced vibration and convert it into an electrical signal. When the threshold of the water flow is greater than the set threshold, the device will show tap on; otherwise, the device state will be shown as tap off. Then it will send these signals to the NodeMCU.



**Fig. 2.33: Piezoelectric vibration sensor**

#### **2.4.2.2 NodeMCU:**

NodeMCU is an open-source platform, which consists of an ESP8266 Wi-Fi-enabled chip. The ESP8266 is a low-cost Wi-Fi chip. NodeMCU has Arduino like analog (A0) and digital (D0-D8) pins on its board. The NodeMCU needs a username and password of the Wi-Fi signal to send the data to an IP address. The NodeMCU gets the signals from the piezoelectric sensor through the analog port. Until the tap becomes off again, it counts the duration of the activity and sends it to the server along with tap id, house id, and the duration.

### 2.4.3 Tap monitoring module (B)

The tap monitoring module (Fig. 2.34) uses a magnetic Hall effect sensor and magnets to detect the water flow rate. It is placed on each tap of the house. It sends data containing tap id, house id, time, flow rate to the server on the completion of water activity.

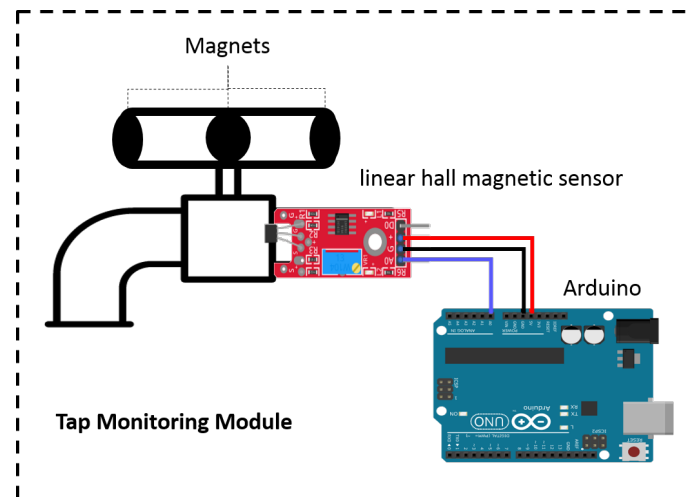

Fig. 2.34: Tap monitoring module (B)

The electrical components of the tap monitoring module are given below:

#### 2.4.3.1 Magnets

Four magnets (Fig. 2.35) are placed on each rotational tap at 0, 90, 180, and 360 degrees to give us north-south directions. They cause a change in magnetic field when a tap is rotated in either direction.

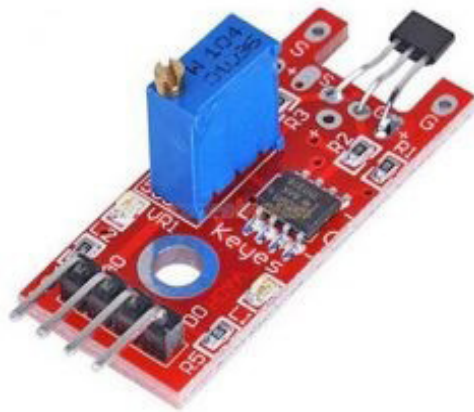

Fig. 2.35: Magnet

#### 2.4.3.2 Linear magnetic Hall sensor

The KY-024 linear magnetic Hall sensor reacts in the presence of a magnetic field. It has a potentiometer to adjust the sensor's sensitivity, and it provides both analog and digital outputs. The analog output can measure the polarity and relative strength of the magnetic field.

The linear magnetic Hall sensor (Fig. 2.36) is fitted on the top of each tap. When the user rotates the tap, it detects the change in polarity and magnetic field and produces a sinusoidal wave which goes to Arduino.

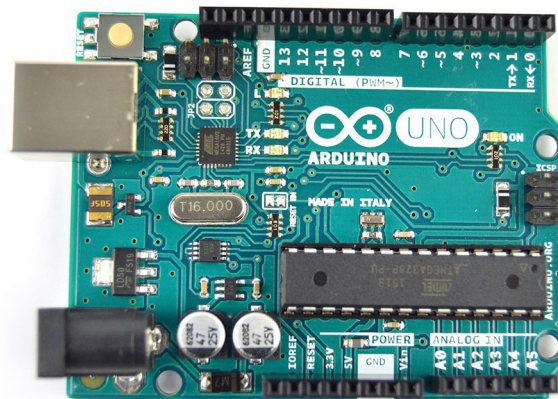

**Fig. 2.36: Linear magnetic Hall sensor**

### **2.4.3.3 Arduino**

Arduino UNO (Fig. 2.37) is simple in use and easily available. It provides large numbers of digital pins, analogue pins, and communication pins. It supports a linear magnetic Hall sensor.

Arduino Mega has a code that deduces how much tap is open using a sinusoidal wave generated by a linear magnetic Hall sensor. It sends tap id, house id, flow rate, and time to the server.



**Fig. 2.37: Arduino UNO**

### **2.4.4 Consumption display module**

The consumption display module displays the litres of water consumed in the previous hour in a house. It sends a message to the server for litres consumed in the past hour; the result appears on the LCD. Fig. 2.38 shows the circuit diagram of the water consumption display module.

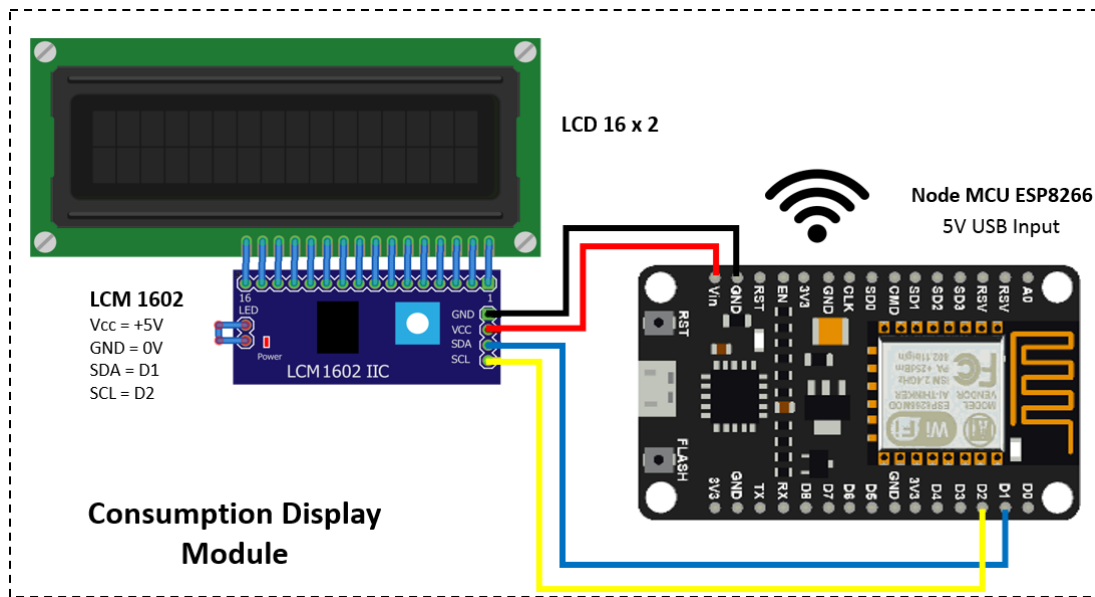

**Fig. 2.38: Water consumption display module**

The water consumption display module consists of the following components.

#### **2.4.4.1 NodeMCU**

NodeMCU is an open-source platform, which consists of an ESP8266 Wi-Fi-enabled chip. The ESP8266 is a low-cost Wi-Fi chip. NodeMCU has Arduino like analog ( $A_0$ ) and digital ( $D_0$ - $D_8$ ) pins on its board. The NodeMCU needs a username and password of the Wi-Fi signal to send the data to an IP address.

NodeMCU sends a message to the server to retrieve water consumed in litres in the past one hour. After receiving the litres as a response, it sends it to I2C for display on LCD. The response contains house id and water consumed.

#### **2.4.4.2 Liquid crystal display**

Liquid crystal display (LCD) shows the output in the visual form (letters, symbols and characters). LCD comes in a various sizes (columns and rows), but a 16×2 display (16 columns and 2 rows) is used to show the output in our project.

To initiate the LCD, write on its control pins and data pins. It has 16 pins containing 8 data pins ( $D_0$ - $D_7$ ) and 3 control pins (RS, R/W, E); other pins are used to power up the display and background light. The brightness of the LCD can be controlled by connecting a potentiometer on pin 3 of the display. LCD is used to show the houses id corresponding to the water consumption status to the consumer (Fig. 2.39).





Fig. 2.39: Liquid crystal display (LCD)

#### 2.4.4.3 LCM1602 IIC (I2C)

LCM1602 IIC interface LCD (Fig. 2.40) requires just 2 pins to display data on LCD, 1 pin for supply (VCC) and 1 pin for GND. While using LCD directly with NodeMCU, 6 pins: RS, EN, D7, D6, D5, and D4 talk to the LCD. For easy implementation, we used I2C to connect LCD to NodeMCU.

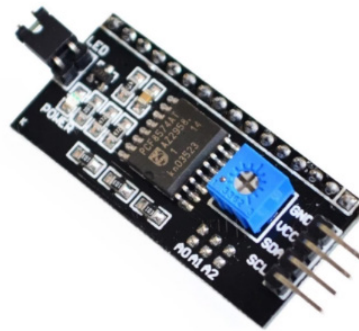

Fig. 2.40: LCM 1602 IIC (I2C)

#### 2.4.5 Server-side module

A Java-based **server** is maintained to store water consumption data from its clients to an online database. For this purpose, **Restful API** is used to send and receive data from IoT devices.

The **database** contains 4 tables (Fig. 2.41): (i) Main inlet table used to store the number of pulses generated from the consumption monitoring module while the water flows through the water flow sensor. (ii) Activity table is used to store tap on, from what time to what time. (iii) Pulses table stores pulses per litre for each tap for calculation of water consumption. (iv) Consumption table stores the hourly water consumption of the houses.

#### 2.4.6 IoT Kit data collection

IoT Kit is installed in a NUST house with 3 bedrooms and 4 washrooms including 1 powder room. The consumption monitoring module is placed near the water tank, while the tap monitoring module is attached to every tap (faucet, shower, etc.). These modules communicate their data to the server. The consumption monitoring module table is presented in Table 2.4.



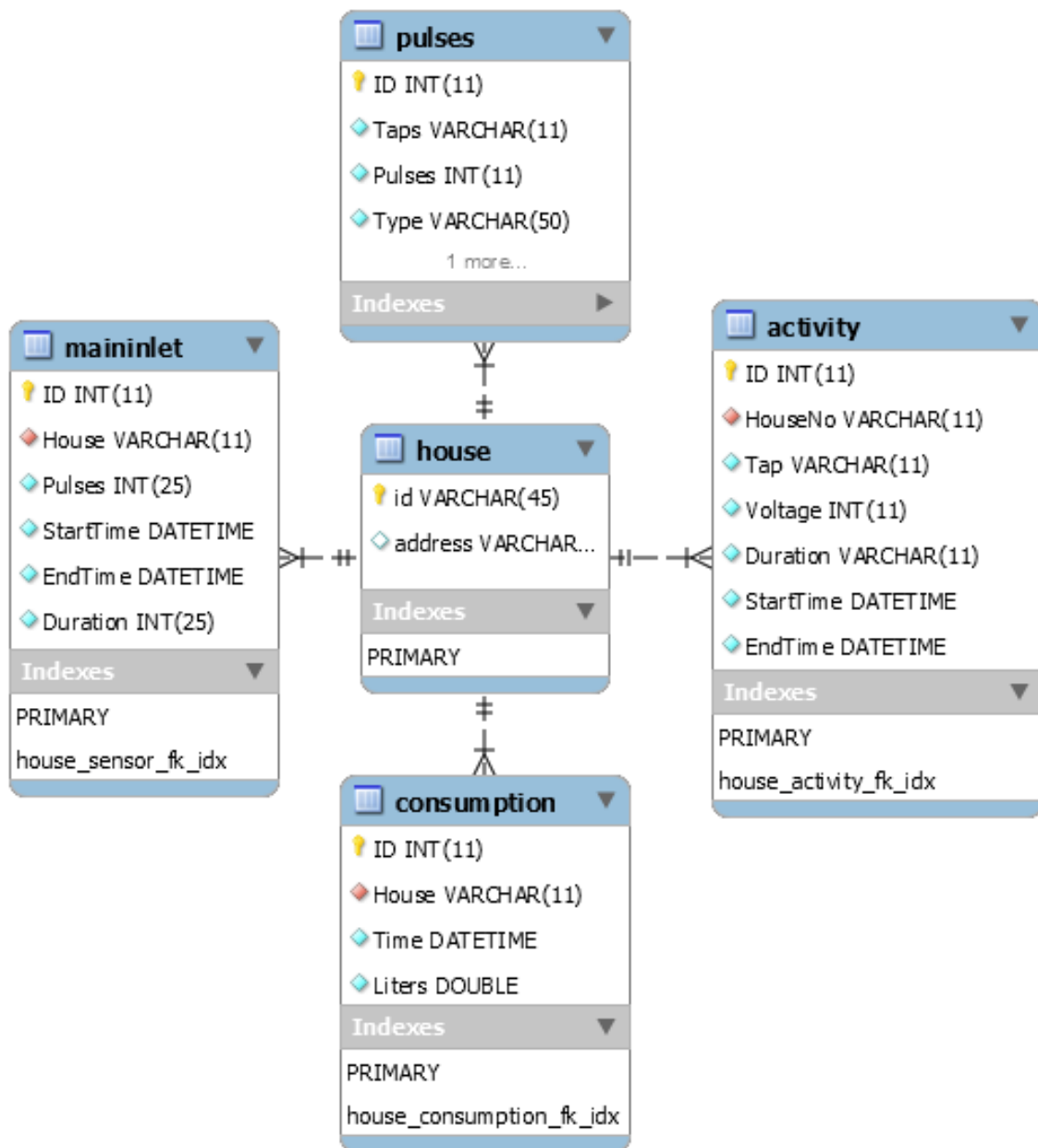

Fig. 2.41: Database tables

**Table 2.4: Consumption monitoring module table**

<b>crimsons_waterdb.maininlet: 549 rows total</b>					
<b>ID</b>	<b>House</b>	<b>Pulses</b>	<b>StartTime</b>	<b>EndTime</b>	<b>Duration (sec)</b>
71	GSA2	27	2019-07-04 06:43:08	2019-07-04 06:43:14	6
73	GSA2	4,011	2019-07-04 06:43:19	2019-07-04 06:45:33	134
75	GSA2	27	2019-07-04 10:14:18	2019-07-04 10:14:22	4
90	GSA2	339,610	2019-07-04 11:02:53	2019-07-04 11:43:33	2,440
8	GSA2	245	2019-07-01 07:25:06	2019-07-04 07:25:11	5
9	GSA2	221	2019-07-02 08:10:44	2019-07-02 08:10:50	6
17	GSA2	10	2019-07-03 17:08:15	2019-07-03 17:08:16	1
18	GSA2	311	2019-07-03 17:09:15	2019-07-03 17:09:26	11
19	GSA2	1410	2019-07-03 17:10:56	2019-07-03 17:11:32	36
20	GSA2	32	2019-07-03 17:12:14	2019-07-03 17:12:16	2
21	GSA2	32	2019-07-03 17:12:22	2019-07-03 17:12:24	2
22	GSA2	662	2019-07-03 17:12:48	2019-07-03 17:13:06	18
23	GSA2	9	2019-07-03 17:19:42	2019-07-03 17:19:45	3
24	GSA2	6,136	2019-07-03 17:19:51	2019-07-03 17:22:38	167
25	GSA2	743	2019-07-03 17:24:44	2019-07-03 17:25:13	29
26	GSA2	641	2019-07-03 18:21:01	2019-07-03 18:21:13	12
27	GSA2	19	2019-07-03 22:00:18	2019-07-03 22:00:26	8
28	GSA2	3,936	2019-07-03 22:00:37	2019-07-03 22:03:13	156
29	GSA2	1	2019-07-03 22:03:14	2019-07-03 22:03:15	1
30	GSA2	16	2019-07-03 23:28:19	2019-07-03 23:28:27	8
31	GSA2	5304	2019-07-03 23:28:33	2019-07-03 23:30:39	126
32	GSA2	648	2019-07-03 23:31:23	2019-07-03 23:31:43	20
33	GSA2	10	2019-07-03 22:48:41	2019-07-03 23:48:44	3
34	GSA2	2	2019-07-03 23:48:45	2019-07-03 23:48:46	1
35	GSA2	8,104	2019-07-03 23:48:55	2019-07-03 23:54:35	340
36	GSA2	370	2019-07-04 02:47:31	2019-07-04 02:47:49	18
37	GSA2	27	2019-07-04 02:48:08	2019-07-04 02:48:11	3
38	GSA2	601	2019-07-04 02:48:19	2019-07-04 02:48:35	16
39	GSA2	71	2019-07-04 02:48:40	2019-07-04 02:48:45	5
40	GSA2	534	2019-07-04 02:54:29	2019-07-04 02:54:40	11
41	GSA2	834	2019-07-04 02:57:26	2019-07-04 02:57:48	22
42	GSA2	5	2019-07-04 02:57:50	2019-07-04 02:57:53	3
43	GSA2	6	2019-07-04 02:57:55	2019-07-04 02:57:59	4

## 2.5 Dashboard and Visualization of Simulation Model

Graphs of the simulator can be viewed by using the following dashboard (Fig. 2.42).

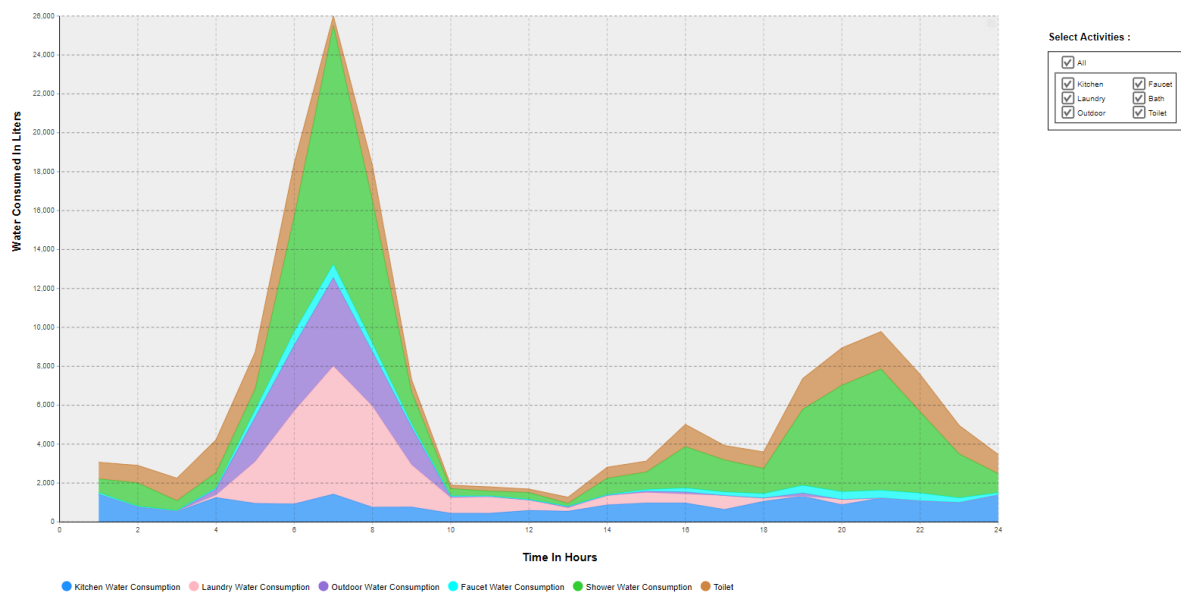

**Fig. 2.42: Dashboard graph view**

The dashboard visualization consists of aggregation functions, datasets, and graphs. Aggregate functions of the agent's population are used instantly to get the total water consumption, total activity-wise water consumption, total available water in rooftop tanks and total unmet demand. These aggregation functions store values in the dataset; their data can be stored in an excel file and seen in the graph. In the visualization layer, three types of graphs are present at the household level and at the neighborhood level: cumulative water consumption, cumulative available water in residential tanks, and unmet demand of a neighborhood over a period of one week. Its duration can be changed.

### 3. RESULTS AND DISCUSSION

This section presents the results of simulations in three categories: (i) at neighbourhood level with 200 houses; (ii) at house level with multiple occupants; and (iii) at the individual level. This study determines the quantum of water consumption at each level at NUST and compares the differences. All the simulation runs are at an hourly resolution and a horizon of 24 hours.

#### 3.1 Neighborhood Level

The results of simulations for water consumption at the neighborhood level (200 houses) are given in Fig. 3.1.

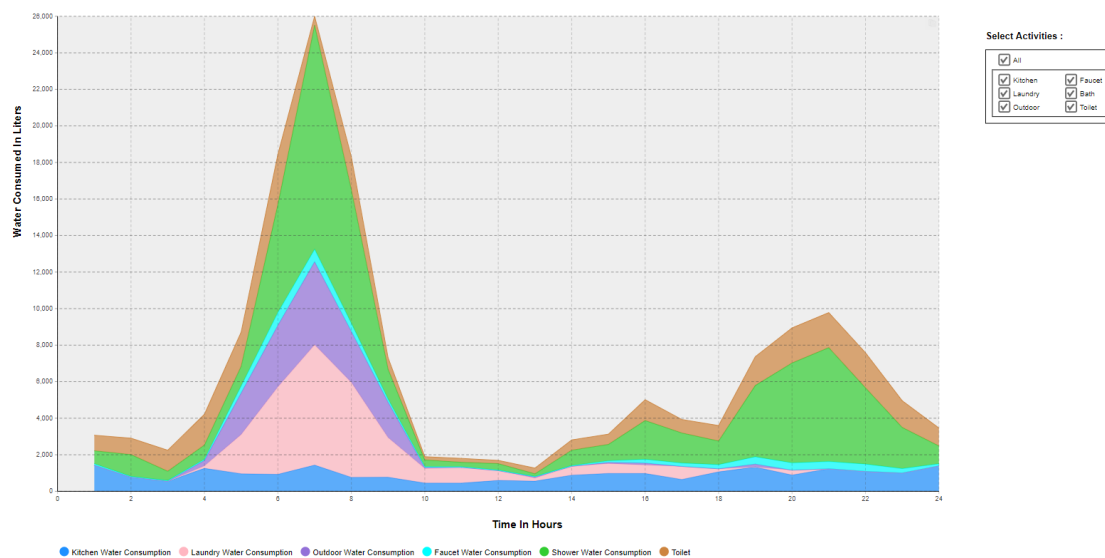

**Fig. 3.1: Water consumption at neighborhood level (200 houses) at NUST, Islamabad**

#### 3.1.1 Daily water consumption of neighbourhood for a month

Fig. 3.2 presents a monthly aggregate of the water consumption in the neighbourhood.

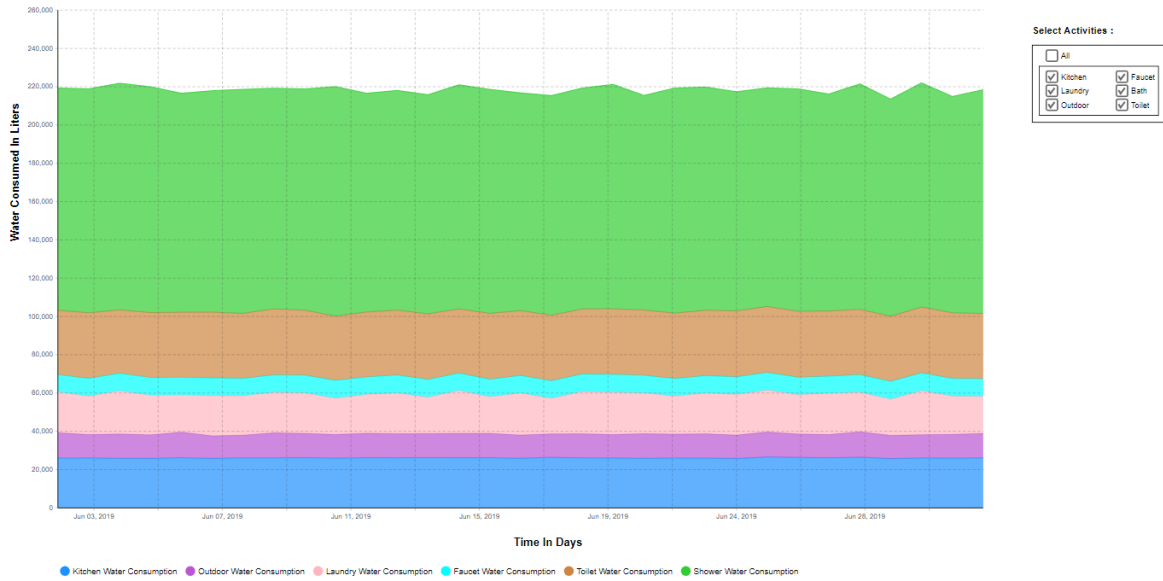

**Fig. 3.2: Monthly aggregate of the water consumption in the neighbourhood at NUST, Islamabad**

### 3.1.2 Daily water consumption of neighbourhood for a year

The data in Fig. 3.3 presents the monthly aggregate of the neighbourhood for a whole year. It can be noticed that there is a slight decline in consumption during winters.

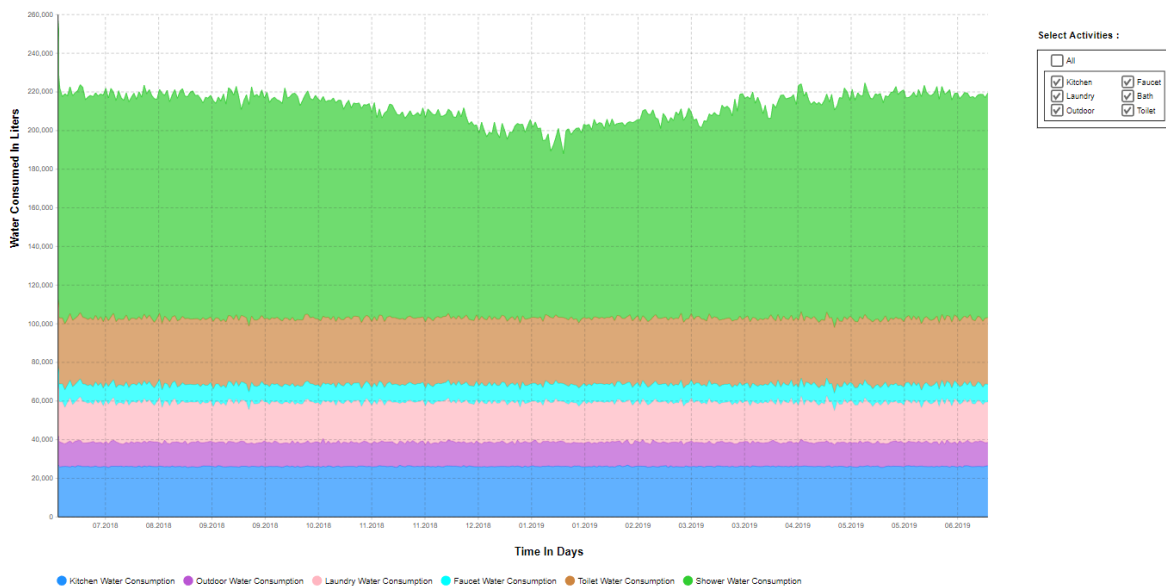

**Fig. 3.3: Monthly aggregate of the water consumption in the neighbourhood for a whole year at NUST, Islamabad**

### 3.2 House Level

Fig. 3.4 shows the simulation run for a typical house for 24 hours. It can be seen that depending on the occupancy of the inhabitants the usage of showering activity is high in the morning and evenings. There is a perpetual use of water in the kitchen during the day to wash dishes and cook food. And regular toilet use is spread throughout the day.

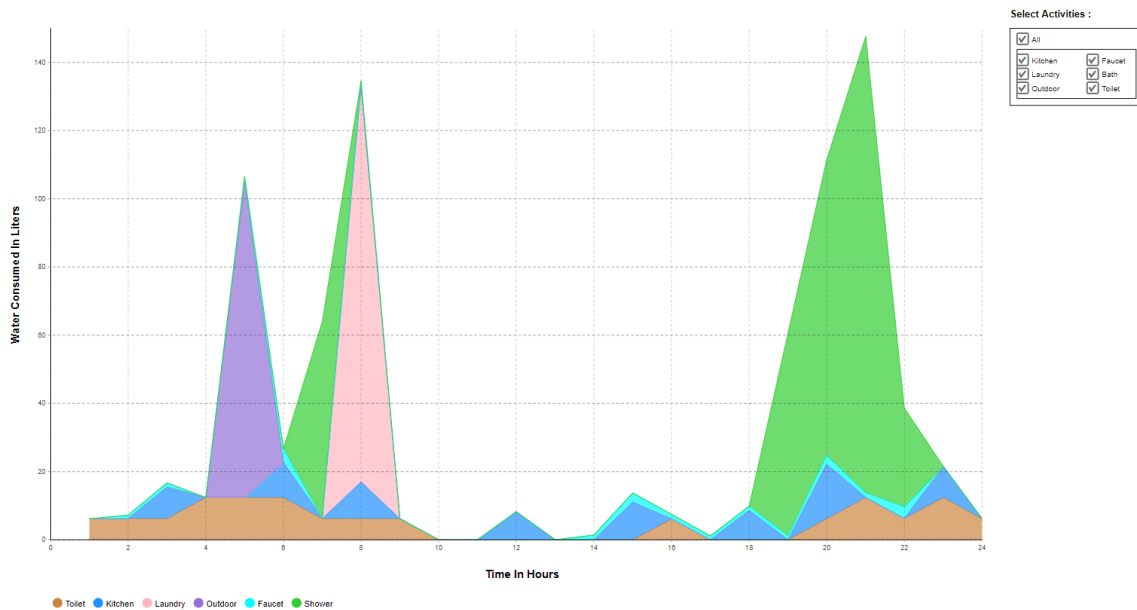

**Fig. 3.4:** Water consumption of a house at NUST, Islamabad

### 3.3 Validation and Discussion

We obtained actual data from NUST Administration and used the Water Evaluation and Planning (WEAP) framework to generate a demand profile of NUST housing monthly demand. This dataset is used for the validation of our simulator. It can be seen from the chart in Fig. 3.5 that the water consumption simulation by our simulator (blue line) fits within the range of the actual demand (red line). However, it is noted that the variance in the pattern of consumption during summer and winter in the actual data is greater than the simulated results. This is because our simulator is only sensitive to temperature in showering activity, which we believe is logical. It is however an open-ended implementation and we can easily map other activities with the change of temperature, e.g., outdoor water use.

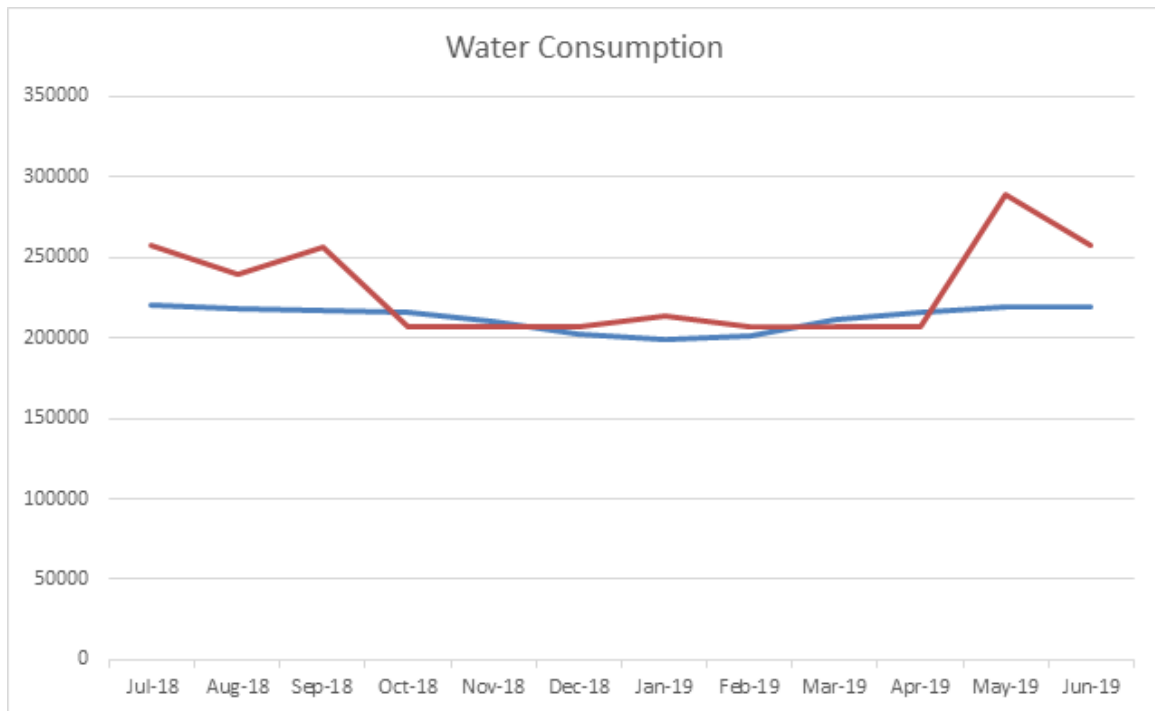

**Fig. 3.5: Actual demand (red line) and simulated (blue line) monthly water consumption of NUST housing**

### 3.4 Research Output

The research output is narrated below in terms of presentation and publication of papers in conference proceedings, publication of research papers, M.Sc.thesis completion by participating students, organization of seminar/open house for disseminating the results to the stakeholders, and submission of research output for patenting.

#### 3.4.1 Conference proceedings

Muhammad Saad Qaisar Alvi, Imran Mahmood, Fahad Javed, Asad Waqar Malik, and Hessam Sarjoughian. (2018). Dynamic behavioural modeling, simulation, and analysis of household water consumption in an urban area: a hybrid approach. In the Proceedings of the 2018 Winter Simulation Conference, WSC '18, Sweden.

#### 3.4.2 Research papers

Based on this study, a research paper is planned on the following topic: Simulation modeling and analysis of household water consumption in Pakistan.

### **3.4.3 M.Sc. thesis**

Three students have participated in the research activities of the project for their MS thesis research. One of them has completed MS degree while the two are expected to complete soon.

1. **Muhammad Saad Qaiser Alvi** has completed his MS thesis on “Behavioral modeling of household water simulation for effective water supply and management”.
2. **Sulman Shaukat** has worked on “Effective water resource management in NUST using Internet of Things” and expected to complete his MS soon.
3. **Romana Ali** has worked on “Multi modeling approach for effective water resource management in NUST” and expected to complete her MS soon.

### **3.4.4 Project results dissemination open house/seminar**

Open House of the project titled “Simulation Modeling and Analysis of Household Water Consumption in Pakistan using Hybrid approach” was held at the International Symposium on the Role of ICT in Water Resource Management, organized by SEECS, NUST on 30<sup>th</sup> July 2019 under the sponsorship of USPCAS-W.

### **3.4.5 Patents**

Applied for Patent of the “Smart Real-time Water Consumption Monitoring and Analysis System (SWANS).



## 4. CONCLUSION AND RECOMMENDATIONS

### 4.1 Conclusion

The report presented a Simulation Modeling and Analysis framework for Household Water Consumption in an urban area of Pakistan using a hybrid ABM and SD approach. This framework allows the modeler to analyse and forecast household water demand, and consists of four modules: (i) AB module, which is used to replicate a person's behaviour and characteristics, (ii) SD module, which allows the modeler to replicate complex and dynamic behaviour of water flow from specific household water-consuming entity, (iii) Visualization and analytics module, which enables the modeler to analyse and forecast demand and supply of water in an urban infrastructure, and (iv) IoT Monitoring KIT, which is deployed in actual houses to collect real-time water consumption data for model validation and calibration.

The simulation framework will help develop strategies/policies for preventive demand-side management and will be used for better planning for supply and resource management. Our validated simulation framework is used for the behavioural analysis of water consumption in the domestic sector. It can be easily extended to industrial, commercial and agricultural sectors using our component-based modeling approach. Eventually, it can be deployed as a decision support system. We further aim to extend the framework to support supply-side modeling at multiple levels of resolution and incorporate water supply management processes under various scenarios of urban infrastructures.

### 4.2 Recommendations

Given the generalized capability of the framework with the convenience of expansion, we have the following research agenda that will strengthen this study and form the basis of a decision support system (DSS) to assist policymakers:

1. The implementation of the model can be conveniently extended on a large scale, e.g., an extension to a regional level can be made, where water demands can be further categorized and prioritized. We are currently looking at this extension, and in this regard, the categories of domestic, industrial, agricultural and ecological demands are under consideration.
2. To facilitate the model extension and its applicability, we aim to integrate our framework with other analytical platforms, which can truly enhance the analytical capabilities of the proposed framework on a regional or country

scale. With the aid of simulating groundwater flow through aquifers using MODFLOW, we can directly project the optimal locations, e.g., to drill tube wells, in the future extensions and evaluate the impact of those resources in terms of future demand fulfillment. This will play a huge role in helping the policymakers and the relevant stakeholders in decision making.

3. We further aim to enhance the visualization tool of the model, with the improved presentation of the results and the capability of the business analysts/stakeholders to conveniently make and execute decisions.
4. We also aim to model a regional setup where scenarios such as surface-water transportation and surface-water/groundwater interaction will be executed to analyze the irrigation demand in detail, which is generally the greatest demand in agricultural countries like Pakistan.

## REFERENCES

- Altaf, M. (2017). Water crisis in Pakistan. *Voice of People, Pakistan Observer, Islamabad*.
- Berglund, E. Z. (2015). Using agent-based modeling for water resources planning and management, *Journal of Water Resources Planning and Management*, doi: 10.1002/gch2.1010, pp. 175-187.
- Borshchev, A. (2013). The big book of simulation modeling. *Multimethod Method with Anylogic 6, United States: Anylogic Inc*.
- Butler, D., Ward, S., Sweetapple, C., Imani, M. A., Diao, K., Farmani R., and Fu, G. (2016). Reliable, resilient and sustainable water management: *The safe and sure approach, Global Challenges*, pp. 63-77.
- Galán, J., López-Paredes, A. and Olmo, R.D. (2009). An agent-based model for domestic water management in Valladolid metropolitan area. *Water Resources Research*. 45: W05401, doi:10.1029/2007WR006536.
- Guterres, A. (2017). The Sustainable Development Goals. *United Nations Multimedia Cell, New York*.
- Iqbal, A.R. (2010). Water shortage in Pakistan – A crisis around. *Institute for Strategic Studies, Research and Analysis (ISSRA), Islamabad*.
- Linkola, L., Andrews C. J. and Schuetze, T. (2013). An agent based model of household water use. *Water*, 5: 1082-1100.
- Moon, Y.B. (2017). Simulation modelling for sustainability: A review of literature. *International Journal of Sustainable Engineering*. 10(1): 2-19.
- SDGs. (2018). Sustainable Development Goals. [Online]. Available: <https://www.un.org/sustainabledevelopment/sustainable-development-goals/>.
- Yang, S.H., Chen, X., Chen, X., Yang, L., Chao, B., and Cao, J. (2015). A case study of Internet of things: A wireless household water consumption monitoring system. *IEEE 2nd World Forum on Internet of Things (WF-IoT)*, pp. 681-686, doi: 10.1109/WF-IoT.2015.7389136.
- Zaher, R., and Badr, G. (2016). Intelligent software simulation of water consumption in domestic homes. *UKSIM-AMSS 18th International Conference on Computer Modelling*, pp: 99-104.

## About the Authors



**Dr. Imran Mahmood** is serving as Assistant Professor and the founding Director of the Center for Research in Modeling & Simulation (CRIMSON) at the Department of Computing, School of Electrical Engineering and Computer Science (SEECs), National University of Sciences and Technology (NUST), Pakistan. He has worked as an Assistant Professor at the School of Computer Science, University of Dammam and the Department of Electrical Engineering, University of Engineering & Technology, Lahore; and supervised ongoing research projects as lead researcher at the Center for Simulation and Visual Analytics Research. He earned a doctoral degree in Software & Computer Systems in 2013 and Master degree in Software Engineering of Distributed Systems in 2007, both at School of Information and Communication Technology (ICT), KTH-Royal Institute of Technology Sweden. He is an active member of ACM & Special Interest Group - Simulation (SIGSIM) and has collaborated with a number of international research groups including: Arizona Center for Integrative Modeling & Simulation – Arizona State University, USA; Systems Integrated Modeling and Simulation (SIMS), Georgia State University, USA and Modeling and Simulation Center (MODSIMMER), Middle East Technical University, Turkey.

**Dr. Naveed Arshad** is presently Associate Professor and Director of the National Center in Big Data and Cloud Computing (NCBC) at Lahore University of Management Sciences. He is also the founder of Energy Informatics Group (EIG) and one of the founding members of Energy Institute at LUMS. Dr. Arshad works in the areas of smart grids, energy and water informatics. His research interests include short, medium and long term forecasting of energy demand, renewable energy generation forecasting for wind and solar resources, demand side management in agricultural, residential and industrial sectors, energy efficiency, and renewable energy integration in existing building stock. Dr. Arshad holds MS and PhD in Computer Science from University of Colorado at Boulder, USA.







Main thrust of Applied Research component of the Water Center is to stimulate an environment that promotes multi-disciplinary research within the broader context of water-development nexus to support evidence-based policy making in the water sector. This is pursued using the framework provided by the six targets of the Sustainable Development Goal on Water i.e. SDG-6.

## Contact:

**U.S.-Pakistan Centers for Advanced Studies in Water**

Mehran University of Engineering and Technology, Jamshoro-76062, Sindh - Pakistan

 92 22 210 9145  [water.muet.edu.pk](http://water.muet.edu.pk)  /USPCASW  /USPCASW